



FIRST® DIVESM
presented by Qualcomm

firstinspires.org/robotics/ftc

2024-2025 FIRST® Tech Challenge

INTO THE DEEP

Competition Manual

INTO THE DEEP

Competition Manual

Contents

1	Introduction	7
1.1	About FIRST®	7
1.2	FIRST® Tech Challenge.....	7
1.3	Gracious Professionalism®, a FIRST Credo	7
1.4	Coopertition®	8
1.5	Spirit of Volunteering.....	8
1.6	Accessibility and Inclusion.....	9
1.7	This Document & Its Conventions	9
1.8	Translations & Other Versions	11
1.9	Team Updates.....	11
1.10	Question and Answer System.....	11
2	FIRST Season Overview	13
3	Competition Eligibility and Inspection (I).....	15
3.1	Team Eligibility Rules	15
3.2	Awards Eligibility Rules	16
3.3	MATCH Eligibility Rules.....	16
4	Advancement.....	19
5	Event Rules (E).....	21
5.1	General Rules	21
5.2	Machine Shops and Host Team Build Spaces	24
5.3	Wireless Rules.....	24
5.4	Load-In.....	25
5.5	Pits.....	25
5.6	ROBOT Carts	27
5.7	Ceremonies	27
5.8	In the Stands	28
6	Awards (A).....	29
6.1	Team Judged Awards Overview and Schedule	29
6.2	Team Judged Award Descriptions	35
6.2.1	Inspire Award.....	35
6.2.2	Think Award.....	36
6.2.3	Connect Award.....	36
6.2.4	Motivate Award	37
6.2.5	Innovate Award sponsored by RTX.....	37
6.2.6	Control Award.....	38

6.2.7	Design Award	38
6.2.8	Judges' Choice Award	39
6.3	Tournament ALLIANCE Awards	39
6.3.1	Winning Alliance Award	39
6.3.2	Finalist Alliance Award	39
6.4	Individual Awards	39
6.4.1	Dean's List Award	39
6.4.2	Compass Award	39
7	Game Sponsor Recognition	41
8	Game Overview	43
9	ARENA	45
9.1	FIELD	46
9.2	Areas, Zones, & Markings	46
9.3	TILE Coordinates	47
9.4	ALLIANCE AREA	48
9.5	SUBMERSIBLE	49
9.5.1	CHAMBERS	50
9.5.2	RUNGS	51
9.6	BASKETS	52
9.7	SCORING ELEMENTS	53
9.7.1	SAMPLES	53
9.7.2	CLIP	54
9.7.3	SPECIMEN	54
9.8	AprilTags	55
9.9	FIELD STAFF	56
9.10	Event Management System	57
10	Game Details	59
10.1	MATCH Overview	59
10.2	DRIVE TEAM	59
10.3	Setup	60
10.3.1	SCORING ELEMENTS	61
10.3.2	DRIVE TEAMS	62
10.3.3	OPERATOR CONSOLES	62
10.3.4	ROBOTS	63
10.4	MATCH Periods	63
10.5	Scoring	63
10.5.1	SAMPLE Scoring Criteria	64
10.5.2	SPECIMEN Scoring Criteria	64
10.5.3	ROBOT Scoring Criteria	65
10.5.4	Point Values	66
10.6	Violations	67
10.6.1	YELLOW and RED CARDS	67
10.6.2	YELLOW and RED CARD application	68

10.6.3	YELLOW and RED CARDS during playoff MATCHES.....	69
10.6.4	Violation Details	69
10.7	Head REFEREE	69
10.8	Other Logistics.....	70
11	Game Rules (G).....	71
11.1	Personal Safety.....	71
11.2	Conduct	71
11.3	Pre-MATCH	75
11.4	In-MATCH.....	78
11.4.1	AUTO.....	78
11.4.2	TELEOP	79
11.4.3	SCORING ELEMENT	79
11.4.4	ROBOT.....	81
11.4.5	Opponent Interaction	84
11.4.6	Human	86
11.5	Post-MATCH	88
12	ROBOT Construction Rules (R).....	89
12.1	General ROBOT Design.....	91
12.2	ROBOT Safety & Damage Prevention.....	95
12.3	Fabrication	96
12.4	ROBOT SIGN Rules	98
12.5	Motors & Actuators	101
12.6	Power Distribution	104
12.7	Control, Command & Signals System	110
12.8	Pneumatic Systems.....	115
	OPERATOR CONSOLE.....	116
13	Tournament (T).....	119
13.1	Overview.....	119
13.2	General Tournament Rules	119
13.3	MATCH Replays.....	120
13.4	Clarifications on MATCH Play Results (“Question Box”).....	122
13.5	Qualification MATCHES	123
13.5.1	Schedule	123
13.5.2	MATCH Assignment	123
13.5.3	Qualification Ranking.....	124
13.6	Playoff MATCHES.....	125
13.6.1	ALLIANCE Selection Process.....	126
13.6.2	Playoff MATCH Bracket.....	126
13.6.3	2-ALLIANCE Bracket and Typical Timing	128
13.6.4	4-ALLIANCE Bracket and Typical Timing	129
13.6.5	6-ALLIANCE Bracket and Typical Timing	130
13.6.6	8-ALLIANCE Bracket and Typical Timing	131
13.7	Dual Division Events	132

13.7.1	Dual Division playoffs	133
14	League Play Tournaments (L)	135
15	FIRST Championship (C)	137
15.1	Advancement to the FIRST Championship	137
15.2	Game Modification	137
15.3	3-ROBOT ALLIANCES	137
15.4	FIRST Championship Pit Crews	138
15.5	FIRST Championship playoffs	138
16	Glossary	139



1 Introduction

1.1 About FIRST®

FIRST® (For Inspiration and Recognition of Science and Technology) was founded by inventor Dean Kamen to inspire young people's interest in science and technology. As a robotics community that prepares young people for the future, FIRST is the world's leading youth-serving nonprofit advancing STEM education. For 30 years, FIRST has combined the rigor of STEM learning with the fun and excitement of traditional sports and the inspiration that comes from community through programs that have a proven impact on learning, interest, and skill-building inside and outside of the classroom. FIRST provides programs that span a variety of age groups:

- FIRST® Robotics Competition for grades 9-12, ages 14-18
- FIRST® Tech Challenge for grades 7-12, ages 12-18
- FIRST® LEGO® League for grades Pre-K-8, ages 4-16
 - FIRST® LEGO® League Challenge for grades 4-8 (ages 9-16, ages vary by country)
 - FIRST® LEGO® League Explore for grades 2-4 (ages 6-10)
 - FIRST® LEGO® League Discover for grades Pre-K-1 (ages 4-6)

Please visit [the FIRST website](https://www.firstinspires.org) for more information about FIRST and its programs.

1.2 FIRST® Tech Challenge

FIRST Tech Challenge is a student-centered program that focuses on giving young people a unique and stimulating experience. Each year, small teams of students with the help of mentors engage in a new dynamic challenge where they design, build, test, and program robots that must perform a series of game tasks autonomously and under driver control. Participants and alumni of FIRST programs gain access to education and career discovery opportunities, connections to exclusive scholarships and employers, and a place in the FIRST community for life. To learn more about FIRST® Tech Challenge and other FIRST® Programs, visit www.firstinspires.org.

1.3 Gracious Professionalism®, a FIRST Credo

Gracious Professionalism® is part of the ethos of FIRST. It's a way of doing things that encourages high quality work, emphasizes the value of others, and respects individuals and the community. *Gracious Professionalism* is not clearly defined for a reason. It can and should mean different things to everyone.

Some possible meanings of *Gracious Professionalism* include:

- gracious attitudes and behaviors are win-win,
- gracious folks respect others and let that respect show in their actions,
- professionals possess special knowledge and are trusted by society to use that knowledge responsibly, and
- gracious professionals make a valued contribution in a manner pleasing to others and to themselves.

In the context of FIRST, this means that all teams and participants should:

- learn to be strong competitors, but also treat one another with respect and kindness in the process and
- avoid leaving anyone feeling as if they are excluded or unappreciated.

Knowledge, pride, and empathy should be comfortably and genuinely blended.

In the end, *Gracious Professionalism* is part of pursuing a meaningful life. When professionals use knowledge in a gracious manner and individuals act with integrity and sensitivity, everyone wins and society benefits.

Figure 1-1: Dr. Woodie Flowers, *Gracious Professionalism* advocate and exemplar



“The FIRST spirit encourages doing high-quality, well-informed work in a manner that leaves everyone feeling valued. Gracious Professionalism seems to be a good descriptor for part of the ethos of FIRST. It is part of what makes FIRST different and wonderful.”

- Dr. Woodie Flowers, (1943 – 2019)
Distinguished Advisor to FIRST

It is a good idea to spend time going over this concept with your team and reinforcing it regularly. We recommend providing your team with real-life examples of *Gracious Professionalism* in practice, such as when a team loans valuable materials or expertise to another team that they will later face as an opponent in competition. Routinely highlight opportunities to display *Gracious Professionalism* at events and encourage team members to suggest ways in which they can demonstrate this quality themselves and through outreach activities.

1.4 Coopertition[®]

At FIRST, *Coopertition*[®] is displaying unqualified kindness and respect in the face of fierce competition. *Coopertition* is founded on the concept and philosophy that teams can and should help and cooperate with one another even as they compete. *Coopertition* involves learning from teammates and mentors. *Coopertition* means competing always but assisting and enabling others when you can.

1.5 Spirit of Volunteering

FIRST can only hope to achieve our mission of providing life-changing robotics programs that give young people the skills, confidence, and resilience to build a better world with your help.

There are two phrases which drive and motivate the individuals that volunteer their time for FIRST: “Giving Back” and “Pay It Forward.” Each year, you have the extraordinary opportunity to help create the best-ever experience for our fellow volunteers, mentors, and students by becoming a FIRST volunteer.

To our team members and mentors: remember that the volunteers you interact with are dedicating their most precious asset - their time - to ensure that all teams have a fulfilling, fun, and memorable competition.

Volunteers are the lifeblood of *FIRST*, and without them, *FIRST* would not be where it is today. We urge you to remember that *Gracious Professionalism* is part of the ethos of *FIRST*. It's a way of doing things that encourages high-quality work, emphasizes the value of others, and respects individuals and the community. We strive to train each volunteer to always exhibit Gracious Professionalism - we hope we can work together to create an environment where all feel safe and welcome.

Please consider volunteering at local events near you but know that not all applicants can be placed in all roles at any given event. Please work with your volunteer coordinator and local Program Delivery Partner (PDP) to help identify the most meaningful way you can help in your region. A complete set of all role-specific volunteer materials can be found on our [Volunteer Resources Page](#).

1.6 Accessibility and Inclusion

FIRST is committed to Equity, Diversity, and Inclusion and as such, *FIRST* makes reasonable accommodations for persons with disabilities that request accommodation. If a participant needs accommodation for an event, please [contact your local leadership](#) before the event so they can help ensure the accommodation is provided. Local leadership may make exceptions to rules to allow for reasonable accommodation given the exceptions do not create an undue hardship or cause safety concerns.

1.7 This Document & Its Conventions

The 2024 Competition Manual is a resource for all *FIRST* Tech Challenge teams for information specific to the 2024 season and the INTO THE DEEPSM presented by RTX game. Its audience will find the following detail:

- a general overview of the INTO THE DEEP game,
- detail about the INTO THE DEEP playing FIELD,
- a description of how to play the INTO THE DEEP game,
- rules (related to safety, conduct, gameplay, inspection, event, etc.),
- ROBOT construction rules, and
- a description of how teams advance at 2024-2025 tournaments and throughout the season.

The intent of this manual is that the text means exactly, and only, what it says. Please avoid interpreting the text based on assumptions about intent, implementation of past rules, or how a situation might be in “real life.” There are no hidden requirements or restrictions. If you’ve read everything, you know everything.

Specific methods are used throughout this manual to highlight warnings, cautions, key words, and phrases. These conventions are used to alert the reader to important information and are intended to help teams in constructing a ROBOT that complies with the rules in a safe manner.

Links to other section headings and rule references within this manual appear in [blue underlined text with a grey background](#). Links to external resources appear [blue underlined text](#).

For linked references not included in a preview release of this document, the links will appear with the section letter and ### for the rules number within square brackets. For example, a cross link to a game rule before a game rule is released will appear as [\[G###\]](#) and will be replaced with the current linked rule when that section of the manual is released.

Key words that have a particular meaning within the context of *FIRST* Tech Challenge and INTO THE DEEP are defined in section [16 Glossary](#) and indicated in ALL CAPS throughout this document.

The rule numbering method indicates the section, subsection, and position of the rule within that subsection. The letter indicates the section in which the rule is published.

- I for Section [3 Competition Eligibility and Inspection \(I\)](#)
- E for Section [5 Event Rules \(E\)](#)
- A for Section [6 Awards \(A\)](#)
- G for Section [11 Game Rules \(G\)](#)
- R for Section [12 ROBOT Construction Rules \(R\)](#)
- T for Section [13 Tournament \(T\)](#)
- L for Section [14 League Play Tournaments \(L\)](#)
- C for Section [15 FIRST Championship \(C\)](#)

The following digit(s) represents the subsection in which the rule can be found. The final digits indicate the rule’s position within that subsection.

Figure 1-2 Rule numbering method

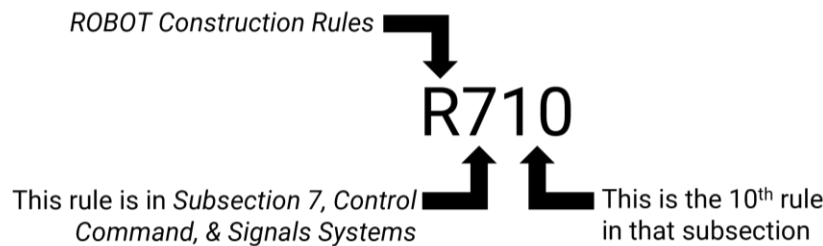

Warnings, cautions, and notes appear in orange boxes. Pay close attention to their contents as they’re intended to provide insight into the reasoning behind a rule, helpful information on understanding or interpreting a rule, and/or possible “best practices” for use when implementing systems affected by a rule.

While orange boxes are part of the manual, they do not carry the weight of the actual rule (if there is an inadvertent conflict between a rule and its orange box, the rule supersedes the language in the orange box).

Imperial dimensions are followed by comparable metric dimensions in parentheses to provide metric users with the approximate size, mass, etc. Metric conversions (e.g., dimensions) round to the nearest tenths, e.g., “17.5 in. (~44.5 cm).” The metric conversions are offered for convenient reference only and do not overrule or take the place of the imperial dimensions presented in this manual and the official drawings (i.e., dimensions and rules will always defer to measurements using imperial units).

Rules include colloquial language, also called headlines, in an effort to convey an abbreviated version of the rule or rule set. There are two versions of headline formatting. Evergreen rules, rules which are expected to go relatively unchanged from season to season, are indicated with their headline presented in ***bold green text** with a leading asterisk. “Relatively unchanged” means that the overall intent and presence of the rule from season to season is constant, but game specific terms may be updated as needed (e.g., changing Cones to Pixels in a rule about what DRIVE COACHES may not contact during a MATCH). These rules also start their respective section, so their rule number is less likely to change from season to season. All other rule headlines use **bold orange text**. Any disagreement between the specific language used in the rules and the colloquial language is an error, and the specific rule language is the ultimate authority. If you discover a disparity, please let us know at firsttechchallenge@firstinspires.org.

Team resources that are not generally season specific (for example, what to expect at an event, communication resources, team organization recommendations, and award descriptions) can be found on the [FIRST Tech Challenge website](#).

1.8 Translations & Other Versions

The *FIRST* Tech Challenge Competition Manual is originally and officially written in English and is occasionally translated into other languages for the benefit of *FIRST* Tech Challenge teams whose native language may not be English. These assets are posted on the [Translated Manuals page](#).

A text-based English version can be provided only for use with assistive devices and not for redistribution. For more information, please contact *FIRST* Tech Challenge at firsttechchallenge@firstinspires.org.

In the event that a rule or description is modified in an alternate version of this manual, the latest English PDF version as published on the Game and Season web page is the authoritative version.

1.9 Team Updates

Team Updates are used to notify the *FIRST* Tech Challenge community of revisions to the official season documentation (for example, the manual, drawings, etc.) or important season news. Team Update posts are scheduled as follows:

- Every other Thursday beginning on kickoff day and ending two weeks prior to *FIRST* Championship.

Team Updates are posted on the Game and Season web page and are generally posted at 1pm Eastern.

Team Updates are indicated using the following formatting:

- Additions are highlighted in yellow. **This is an example.**
- Deletions are indicated with a strikethrough. ~~This is an example.~~

1.10 Question and Answer System

The [Question and Answer System \(Q&A\)](#) is a resource for teams to ask questions about gameplay, competition rules, judging and advancement, ROBOT build rules, and FIELD setup. Teams can search for previously asked questions and responses or pose new questions. Questions can include examples for clarity or reference multiple rules to understand the relationships and differences between them.

The Q&A opens on September 16, 2024, 12:00p.m. ET. Access to the Game Q&A forum is through the Lead Coach/Mentor 1 and/or Lead Coach/Mentor 2's account on the [FIRST dashboard](#). Follow the instructions on [how to create an official Q&A account](#). Teams may still create a separate view-only account to read the forum.

The Q&A may result in revisions to the text in the official manuals (which are communicated using the process described in section [1.9 Team Updates](#)).

Moderators will answer team questions beginning each Monday, and close on Thursday at 12:00pm ET. The responses in the Q&A do not supersede the text in the manual, although every effort will be made to eliminate inconsistencies between the two. While responses provided in the Q&A may be used to aid discussion at each event, REFEREES and INSPECTORS are the ultimate authority on rules. If you have concerns about enforcement trends by volunteer authorities, please notify *FIRST* at firsttechchallenge@firstinspires.org.

The Q&A is not a resource for firm predictions on how a situation will play out at an event. Questions about the following may not be addressed:

- rulings on vague situations
- challenging decisions made at past events
- design reviews of a ROBOT system for legality
- questions that are overly broad, vague, and/or include no rule references

Some examples of questions that may not be answered in the Q&A are:

- how should the REFEREE have ruled when this specific gameplay happened?
- duplicate questions
- questions clearly defined/addressed in this manual

Good questions ask generically about features of parts or designs, gameplay scenarios, or rules, and often reference one or more relevant rules within the question. Some examples of questions that will likely be answered in the Q&A are:

- A device we are considering using on the ROBOT comes with purple AWG 40 wire, does this comply with R?? and R??
- We're not sure how to interpret Rule G?? applies if blue ROBOT A does X and red ROBOT B does Y, can you please clarify?
- If a ROBOT does this specific action, is it doing what this defined term is describing?

Questions from "FTC 1000" represent content asked by key volunteers (e.g., REFEREES, INSPECTORS), answered by *FIRST*, and are considered relevant to teams.



2 FIRST Season Overview



Explore the Future

The ocean is more than what you can see on the horizon. Beneath the surface lies our planet’s most complex ecosystems, full of life and potential for exploration and learning, where each inhabitant has a role to play in building a thriving environment.

During the 2024-2025 FIRST season, FIRST® DIVESM presented by Qualcomm, teams will use their STEM and collaboration skills to explore life beneath the surface of the ocean. Along the way, we’ll uncover the potential in each of us to strengthen our community and innovate for a better world with healthy oceans. Join us as we explore the future.



PRESENTED BY  RTX

PRESENTED BY  HAAS
Good Works FOUNDATION

Children can join any of our three programs based on age or grade level. Ages may vary by region.



AGES
4-16



AGES
12-18



AGES
14-18

LEARN MORE: firstinspires.org/dive

3 Competition Eligibility and Inspection (I)

3.1 Team Eligibility Rules

I101 ***Teams must be registered with FIRST.** Teams must be “competition ready” in order to compete in FIRST Tech Challenge official events and earn MATCH points or be eligible for judged awards.

- A. North America - competition ready requirements:
 - i. complete annual registration process through the *FIRST* dashboard
 - ii. pay annual registration fee
 - iii. two adults must be assigned in the Lead Coach/Mentor 1/Lead Coach/Mentor 2 roles and have passed [Youth Protection Program \(YPP\) screening](#)
 - iv. register all youth team members on the *FIRST* dashboard
- B. Outside North America - competition ready requirements:
 - i. complete annual registration process through the *FIRST* dashboard
 - ii. complete any additional requirements by the local *FIRST* Program Delivery Partner with regards to program fees, registrations and youth protection screening.

The local Program Delivery Partner may make exceptions for delayed payment on a case-by-case basis. Teams who have not paid annual registration fees will not earn any official season record and will not be allowed to advance.

I102 ***Check-in at the event on time.** Teams must check-in by the check-in deadline listed on the public event schedule or as instructed by the Event Director. Check-in must be completed by a team adult and at least one STUDENT must be present at the venue before check-in can be completed.

Additional check-in requirements will vary by region but may require one or more of the following items:

- A. team roster from the team’s [FIRST dashboard](#) (North America only)
- B. local Program Delivery Partner team member registration or consent forms (varies by region)
- C. A ROBOT built to play the current season’s game if they intend to participate in MATCHES
- D. printed judging support materials (optional, see section [6 Awards \(A\)](#))

All teams, regardless of how “ready” they think they are, are encouraged to participate in ROBOT gameplay and judging. Teams are encouraged to reach out to their Program Delivery Partner and other teams to request help getting their ROBOT ready to compete before attending an event.

Teams who do not wish to or do not feel ready to participate in judging or ROBOT gameplay should notify their Program Delivery Partner before the event if at all possible, for scheduling purposes.

I103 ***A responsible adult must be present for the whole event.** At least one, preferably two, adult(s) responsible for the STUDENT team members must be present at all times during the event. Adults attending *FIRST* Tech Challenge events are expected to follow the same rules as youth participants.

3.2 Awards Eligibility Rules

Complete details and rules about *FIRST* Tech Challenge judged awards can be found in section [6 Awards \(A\)](#).

Notable changes from last season:

- A. Control Award does not have a separate submission form and should be included in the PORTFOLIO.
- B. Promote Award has been retired.
- C. not submitting a PORTFOLIO no longer eliminates a team from all Judged Award considerations.
- D. recording audio or video is not permitted during interviews.

3.3 MATCH Eligibility Rules

This section describes the rules governing MATCH participation. A team has participated in a MATCH if any member of their DRIVE TEAM is in the ALLIANCE AREA, with or without the ROBOT on the FIELD, at the start of the MATCH.

This section describes the rules and requirements for team participation in MATCH play. ROBOTS are required to pass ROBOT inspections before being allowed to compete. These inspections are to help ensure that all section [12 ROBOT Construction Rules \(R\)](#) are satisfied.

At each event, the lead ROBOT INSPECTOR (LRI) has final authority on the legality of any COMPONENT, MECHANISM, or ROBOT. INSPECTORS may re-inspect ROBOTS at any time to ensure compliance with the rules. Teams are expected to consult with INSPECTORS or the LRI if they have any questions regarding the legality of a ROBOT or about how to make a ROBOT legal.

The inspection process may progress in blocks, i.e., it may pause for a team to make a correction. The process may employ various INSPECTORS throughout the process based on availability. At the team's discretion, they may request a different INSPECTOR or invite the lead ROBOT INSPECTOR to participate in their ROBOT'S inspection.

Events may assign specific inspection time slots for teams to better facilitate a quick and orderly inspection process. Teams should plan to report to their assigned inspection times fully ready to complete inspection.

Prior to the start of a MATCH, any ROBOT which is unable or ineligible to participate in that MATCH, as determined by the team, *FIRST* Technical Advisor (FTA), LRI, or Head REFEREE, is DISABLED and can be removed from the FIELD with permission of the Head REFEREE or FTA. A team whose ROBOT is DISABLED or not present is eligible to receive qualification MATCH Points or playoff MATCH points provided that its ROBOT has passed inspection, per [I302](#), and as long as at least one STUDENT DRIVE TEAM member is present in the ALLIANCE AREA.

An [Inspection Checklist](#) is available to help teams self-inspect their ROBOT before their event. Teams are strongly encouraged to self-inspect prior to their event.

I301 *It is your team's ROBOT. The ROBOT and its MAJOR MECHANISMS must be built by the *FIRST* Tech Challenge team that has registered for the event and intends to use the ROBOT to participate in MATCHES or as part of judged awards.

A MAJOR MECHANISM is a group of COMPONENTS and/or MECHANISMS assembled together to address at least 1 game challenge: ROBOT movement, SCORING ELEMENT manipulation, FIELD element manipulation, or performance of a scorable task without the assistance of another ROBOT.

This rule requires that the ROBOT and its MAJOR MECHANISMS were built by its team but is not intended to prohibit or discourage assistance from other teams (e.g., fabricating elements, supporting construction, writing software, developing game strategy, contributing COMPONENTS and/or MECHANISMS).

Examples that would generally not be considered MAJOR MECHANISMS, and thus are not subject to this rule include, but are not limited to, the following:

- A. a gearbox assembly,
- B. a COMPONENT or MECHANISM that is part of a MAJOR MECHANISM, or
- C. COTS items.

I302 *Get inspected before playing a qualification/playoff MATCH. A team is only permitted to participate in a qualification or playoff MATCH and receive RANKING POINTS if their ROBOT has passed an initial, complete inspection. INSPECTORS are available to help, but teams are expected to ensure their ROBOT and other supporting equipment are within the rules at all times when competing.

Violation: If prior to the start of the MATCH, the team is DISQUALIFIED and not eligible to participate in the MATCH. If after the start of the MATCH, the team receives a RED CARD for that MATCH.

I303 *Bring the complete ROBOT and supporting equipment to inspection. At the time of inspection, the OPERATOR CONSOLE and the ROBOT with battery must be presented with all MECHANISMS (including all COMPONENTS of each MECHANISM), configurations, and decorations that will be used on the ROBOT in MATCHES without re-inspection per [I304](#).

- A. ROBOTS are allowed to play MATCHES with a subset of the MECHANISMS that were present during inspection. Only MECHANISMS that were present during inspection may be added, removed, or reconfigured between MATCHES. The ROBOT should be assembled in a typical configuration used for MATCH play when reporting for inspection. ROBOT and all MECHANISMS must be inspected in every STARTING CONFIGURATION.
- B. If MECHANISMS are swapped out between MATCHES, the reconfigured ROBOT must still meet all rules.
- C. The total of all electronics (motors, servos, Android Devices, etc.) used to build all MECHANISMS and base ROBOT, whether they are used on the ROBOT at the same time or not, may not exceed the constraints specified in section [12 ROBOT Construction Rules \(R\)](#).

I304 *Unless the change is listed below, any change to a ROBOT must get re-inspected. A ROBOT may play MATCHES with a subset of the MECHANISMS that were present during inspection provided the reconfigured ROBOT still complies with all ROBOT construction rules. Only MECHANISMS that were present during the inspection may be added, removed, or reconfigured between MATCHES without re-inspection per this rule. If a ROBOT is modified after its most recently passed inspection, it must be re-inspected before the ROBOT is eligible to participate in a MATCH.

Exceptions are listed below (unless they result in a significant change to the ROBOT'S size, legality, or safety).

- A. addition, relocation, or removal of fasteners (e.g., cable ties, tape, and rivets),
- B. addition, relocation, or removal of labeling or marking,
- C. addition, relocation, or replacement of the team SIGN,

- D. revision of ROBOT code,
- E. replacement of a COTS COMPONENT with an identical COTS COMPONENT,
- F. replacement of a MECHANISM with an identical MECHANISM (size, weight, material), and
- G. additions, removals, or reconfiguration of ROBOT with a subset of MECHANISMS already inspected per [I303](#)

Violation: ROBOT must be inspected before participating in a MATCH or the team will receive a RED CARD.

I305 ***Do not exploit re-inspection.** Teams may not use the re-inspection process in [I304](#) to circumvent any other rules.

I306 ***ROBOTS can be powered on for inspection only for specific verification steps.** For the safety of all those involved, ROBOTS must be presented for inspection with the ROBOT powered off and springs or other non-electrical stored energy devices in their lowest potential energy states (e.g., springs relaxed).

Power should only be enabled on the ROBOT during those portions of the inspection process where it is required to validate certain system functionality and compliance with specific rules (software check, etc.). INSPECTORS may allow the ROBOT to be powered beyond the parameters above if both criteria below are met:

- A. the ROBOT design requires power or a charged stored energy device in order to confirm that the ROBOT meets STARTING CONFIGURATION requirements and
- B. the team has included safety interlocks that mitigate unexpected release of such stored energy.

Batteries can remain installed in the ROBOT for inspection, but all other stored energy from springs or other material deformation should be in the most relaxed low energy state possible.

The team may be asked to demonstrate these interlocks during the inspection process.

I307 ***STUDENTS must be present during the inspection process.** At least 1 STUDENT team member must accompany the ROBOT for any inspection efforts.

Exceptions may be made for major conflicts, e.g., religious holidays, major testing, transportation issues, etc.

Violation: Inspection will not continue until a STUDENT is present.



4 Advancement

Teams are only eligible to advance from events within their own region. Teams may be invited to compete at tournaments outside of their region, however, they do so for the opportunity of additional gameplay and to compete with other teams from outside of their area and are not advancement eligible from these out-of-region events.

Teams can check what region they are assigned to on the [FTC Events](#) page by looking up their team number. Teams in regions that do not have a local Program Delivery Partner, or who are geographically isolated within their home region can work with FIRST by emailing ftcteams@firstinspires.org to get reassigned to another more accessible region for advancement.

Figure 4-1: Region assignment display on FTC Events page



FIRST Tech Challenge tournament progression is shown in Figure 4-2. Teams can advance from any of their first three entry-level events: Qualifying Tournaments (QT) and League Tournaments (LT). Teams may only participate in one league per season. See section [14 League Play Tournaments \(L\)](#) for more details on League Tournaments. Teams may participate in more than 3 entry-level events, but they are not eligible for advancement from those events.

Figure 4-2: Tournament advancement structure

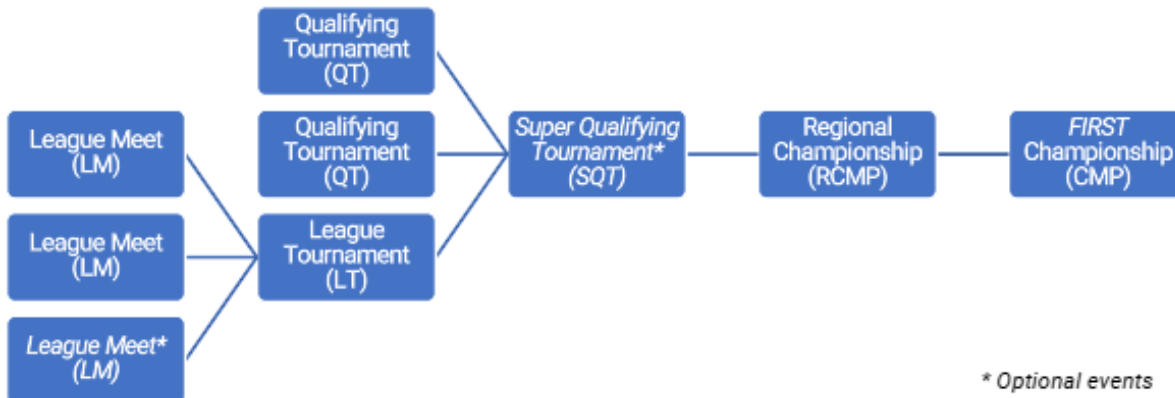

Teams may advance from their Qualifying Tournaments or League Tournament to either a Super Qualifying Tournament (SQT) or directly to a Regional Championship (RCMP). Super Qualifying Tournaments (SQT) are an optional advancement level often used in large regions which need more levels of competition. A team may only participate in one Super Qualifying Tournament.

The local Program Delivery Partner determines the advancement numbers from each tournament in their region, up to a Regional Championship. FIRST Headquarters staff determine the advancement from each Regional Championship to the FIRST Championship.

If the team listed has already advanced or is ineligible for advancement, selection will continue down the list in Table 4-1 until all available advancement slots are filled.

Table 4-1: Advancement Order

Single Division Events 4-10 Teams	Single Division Events ≥11 Teams	Dual Division
0	<i>Qualifying Tournament Host Team*</i>	
1	Inspire Award, 1 st Place	
2	Event 1 st Place Alliance Captain	
3	Event 1 st Place Alliance Partner	
4	Think Award, 1 st Place	Inspire Award, 2 nd Place
5	Connect/Motivate Award	Inspire Award, 3 rd Place (if Awarded)
6	2 nd Place Alliance Captain	2 nd Place Alliance Captain
7	Design/Control/Innovate Award	Think Award, 1 st Place
8	2 nd Place Alliance Partner	2 nd Place Alliance Partner
9		Connect Award, 1 st Place
10		2 nd Place Alliance Captain, winning division
11		Innovate Award, 1 st Place
12		2 nd Place Alliance Captain, finalist division
13		Control Award, 1 st Place
14		Motivate Award, 1 st Place
15		Design Award, 1 st Place
16		2 nd Place Alliance Partner, winning division
17		2 nd Place Alliance Partner, finalist division
18**	Next Highest Ranked Team not already advanced	Next Highest Award (2 nd and 3 rd places) Not Already Advanced
19**		Next Highest Ranked Team not already advanced, winning division
20**		Next Highest Ranked Team not already advanced, finalist division

*At the discretion of the Program Delivery Partner, a Qualifying Tournament (QT) host team may be granted advancement. The team must still compete at one other tournament within the region.

**If advancement selection goes beyond the 20th position, rows 18-20 will repeat as needed.



5 Event Rules (E)

This section includes general rules which apply from the beginning of the public schedule when teams arrive through the end of the event with departure from the venue. They are high-level rules intended to promote an orderly and safe experience for all participants. The Event Director may specify additional restrictions beyond those listed here based on local venue requirements.

Safety is always paramount, and many rules are intended to establish norms at each event that will mitigate injury risk to all participants.

The Event Director has the final decision authority for all safety-related issues within a venue.

5.1 General Rules

The rules below apply throughout an event from the beginning of the public schedule when teams arrive through the end of the event with departure from the venue.

Universal Violation Note: A violation of any [Event Rules \(E\)](#) will result in a verbal warning. Egregious or subsequent violations will be addressed by the Head REFEREE, the lead ROBOT INSPECTOR (LRI) and/or Event Director and may result in disqualification for the team from MATCHES and awards. Criminal behavior will not be tolerated and will result in removal of individual(s) involved and/or disqualification for the team from the event.

Additional rule specific violations, if applicable, are listed with their corresponding rule.

E101 *Personal safety comes first. All team members must observe the following safety practices throughout the event:

- A. wear safety glasses or safety rated glasses with side shields (ANSI-approved, UL Listed, CE EN166 rated, AS/NZS certified, or CSA rated) while in and around the playing FIELD and in the pit area. Clear or lightly tinted safety glasses are preferred. Shaded glasses are allowed for those who need them and do not require a specific accommodation request. The only instances where teams are not required to wear safety glasses are in their first 10 minutes of their event load in, and for the first 10 minutes pits are open each day of the event as long as they're not working on the ROBOT or setting up their pit.
- B. wear closed toed/heeled shoes.
- C. control entanglement risks by tying back long hair and removing other dangling decorations including lanyards, spirit wear and rings as needed while working on or around a ROBOT or ROBOT related materials or tools.
- D. wear appropriate clothing.
- E. walk in the venue.
- F. comply with government and venue-specific health and safety requirements in place for that event (i.e., mask wearing).

Teams are responsible for bringing their own personal protective equipment.

For more information about safety at FIRST events, please reference the [FIRST Safety Manual](#).

E102 *Be a Gracious Professional. All participants must be gracious and professional at all times while attending a FIRST Tech Challenge event. Uncivil behavior toward any participants is not tolerated.

Examples of inappropriate behavior include, but are not limited to:

- A. use of offensive language or other uncivil conduct towards someone,
- B. intentionally blocking the view of other participants or spectators for an extended period (Team members momentarily holding up team signs while directly supporting their team is not considered a violation of this rule.), and
- C. jamming or interfering with the remote sensing capabilities of a ROBOT or the FIELD while in open-access spectator seating areas.

Examples of remote sensing capabilities include, but are not limited to, vision systems, acoustic range finders, sonars, and infrared proximity sensors.

Use of imagery that, to a reasonably astute observer, mimics the AprilTags employed on the FIELD is a violation of this rule.

Examples of particularly contemptible behavior that may result in ejection from the event include, but are not limited to, the following:

- A. assault, e.g., throwing something that hits another person (even if unintended),
- B. threat, e.g., saying something like “if you don’t reverse that call, I’ll make you regret it,”
- C. harassment, e.g., badgering someone with no new information after a decision has been made or a question has been answered,
- D. bullying, e.g., using body or verbal language to cause another person to feel inadequate or unsafe,
- E. insulting, e.g., telling someone they do not deserve to be on a team,
- F. swearing at another person (versus swearing under one’s breath or at oneself), and
- G. yelling at another person(s) in anger or frustration.

E103 *Children with adults, please. Children under 12 must be accompanied in the pits by an adult at all times.

E104 *Respect the venue. Teams may not damage the venue, including but not limited to bleachers, floors, walls, railings, in any way. This includes littering with team giveaways including candies, flyers and stickers.

E105 *Teams must check in. An adult team member must check in at the Pit Administration station, or the designated check in location, no later than 45 minutes before qualification MATCHES are scheduled to start unless otherwise specified or approved by the Event Director.

Violation: Failure to check in may result in a team not participating in the event.

E106 *Event resources are for competing teams only. Only teams registered for an event may use that event’s competition FIELD, practice FIELD, and inspection unless pre-approved by the Event Director or the Program Delivery Partner. Host teams supplying practice FIELD elements and/or machine shop resources may use them, however teams registered for that event must be granted priority.

E107 *Practice only when/where permitted. Teams may only practice with their ROBOT in their pit space, in the designated event practice areas, or while in a practice MATCH.

Teams may not set up their own practice equipment outside their pit in other areas of the event venue. When practicing in their pit, safety must remain the top priority. If the Event Director determines a pit practice setup is unsafe or interferes with activity in adjacent pits or aisles, the team must discontinue the activity.

E108 *Work in designated areas only. At the event venue, teams may only produce FABRICATED ITEMS as follows:

- A. in their pit area,
- B. in another team's pit area with permission from that team,
- C. while queued for a MATCH or practice FIELD (given space constraints, extra scrutiny regarding safety is required),
- D. any area designated by event staff (e.g., playoff pit area), or
- E. as permitted at provided machine shops that are available to all teams.

E109 *Some things do not belong at events. Do not bring or use the following:

- A. skateboards
- B. 'hoverboards'
- C. drones
- D. bottled gas tanks (e.g., helium)
- E. noisy devices or noisemakers, such as floor stompers, whistles and/or air horns
- F. walkie-talkies
- G. scooters, except for those used for accommodations

E110 *Do not arrange for additional utilities. Do not arrange for power, internet access, or phone lines from venue service providers or attempt to use venue internet connections reserved for event purposes (e.g., FIRST event management software or web casting).

E111 *Do not sell stuff. Teams may not conduct sales at an event. This includes, but is not limited to, raffle tickets, food, hats, shirts, candy, water, soft drinks, fruit, or any promotional products unless specifically allowed by the Event Director.

E112 *Make FIRST loud, but with restrictions. Do not invite or bring live bands to play in the audience. Do not play loud music.

E113 *Hang banners with care. Be respectful when hanging your banners.

- A. Do not cover or move other team or sponsor signs already in place.
- B. Share the available space fairly with other teams.
- C. Do not obstruct the view of spectators.
- D. Get permission from the Event Director before hanging banners outside of your pit.
- E. Hang signs and banners in a safe manner.
- F. Banners hung outside team pits must not be larger than 25 ft.² (2.3 m²).

We encourage teams to bring team flags and/or signs for display in their pits and/or the ARENA.

Respect venue-specific rules regarding sign location and hanging methods. At the end of the event, safely remove all signs and anything used to hang the signs (tape, string, etc.).

- E114** ***Limit flag and flagpole size if used in the ARENA.** Flags and flagpoles may not be of unreasonable size and weight if they are going to be used around the FIELD.

As a guideline, reasonable flags are less than 3 ft. by 5 ft. (~91 cm by 152 cm) in size and weigh less than 2 lbs. (~907g). Reasonable flagpoles may not be more than 8 ft. (~243 cm) long and must weigh less than 3 lbs. (~1360g).

- E115** ***No firearms or other weapons.** Firearms or other weapons are prohibited at all *FIRST* events for all *FIRST* programs, including without limitation, [all official FIRST Events posted here](#). This rule includes prop or simulated weapons which appear to be real. This policy does not apply to law enforcement or venue security personnel.
- E116** ***Inspection required for practice FIELD access.** A team may only use a practice FIELD with a ROBOT that has passed an initial, complete inspection. This rule only applies to events not using scheduled inspection times.
- E117** ***Do not record FIRST staff or volunteers at the event without their consent.** Teams and their guests may not record interactions with *FIRST* event staff, or anyone at an event, without the person's consent. *FIRST* event staff and volunteers are empowered to excuse themselves from an interaction in which they are being recorded after declining consent.

Laws regarding recording of conversations vary state-to-state and country-to-country, and, in some cases, recording without consent may be criminal. Introducing the idea of recording a conversation with an implied reason of proving someone's error can escalate a discussion and is likely to increase its adversarial nature.

5.2 Machine Shops and Host Team Build Spaces

Rarely, some events host a machine shop or open their team's build space, during specific hours (see the event public agenda), to help teams with repair and fabrication of their ROBOT. Machine shops are typically sponsored by the local host organization. In most cases, the machine shop is on site and readily accessible to all teams. All competing teams should have access to the same resources.

5.3 Wireless Rules

- E301** ***No wireless communication.** Teams may not set up their own Wi-Fi (802.11a/b/g/n/ac/ax/be) wireless communication (e.g., access points or ad-hoc networks), Bluetooth, or any other communications systems using 2.4GHz or 5GHz wireless in the venue.

A wireless hot spot created by a cellular device, camera, smart TV, etc. is considered an access point.

Some smart TVs have access points enabled by factory default. Please make sure that functionality is disabled for any TVs brought to the event.

Bluetooth uses 2.4GHz frequencies to communicate which can interfere with venue and ROBOT systems.

Many R/C toys (including drones, wireless vehicles, FPV systems) use 2.4GHz and 5GHz communications. Do not operate these in the venue.

E302 ***Don't interfere with wireless networks.** Participants may not interfere, attempt to interfere, or attempt to connect with any other team or *FIRST* wireless network without expressed permission.

Teams are encouraged to report suspected wireless security vulnerabilities to the *FIRST* Technical Advisor (FTA) or Event Director if at the event or to *FIRST* via ftctech@firstinspires.org to report a suspected issue after the event.

Violation: Verbal warning, plus subsequent and/or egregious violations may lead to dismissal from the event and/or legal action based on applicable laws.

5.4 Load-In

Some large events (often multi-day events) may set specific time frames, published on the event public schedule, in which teams are invited to load their ROBOT and equipment into their pit areas before pits officially open.

Load-in can be stressful for teams and volunteers, which can be mitigated by preparation and planning. Unanticipated factors, like traffic or weather, can change a team's scheduled arrival time, making the process difficult. The most important things a team should remember are to be safe, gracious, and professional. Teams who experience smooth and easy load-ins are encouraged to check with others to see if they can help and make their experience as positive as possible.

5.5 Pits

A team pit is the designated space, typically a 10 ft. by 10 ft. by 10 ft. (~3 m x 3 m x 3 m) area, where a team may work on their ROBOT. Each team is assigned a pit space marked with their team number. This helps team members, judges, and visitors find teams easily. Pit spaces may vary based on competition venue size limits.

The pit area refers to the general area where team pits are located which encompasses the aisles between the pits, pit admin, ROBOT inspection, practice FIELD, or other areas where ROBOTS may be active or worked on. All pit rules apply to the full pit area.

Additional limitations beyond those listed below may be imposed by the Event Director but they should be clearly communicated at least 48 hours before the event start time and applied to all teams fairly. Team pits may or may not have a table and power outlet. If individual team outlets are not provided, the venue must provide access to team-usable outlets in the pit area for charging batteries. Power may not be available overnight for a multi-day event.

Teams, volunteers, *FIRST* staff, and guests spend a lot of time in the pits. Get to know other teams and help each other when you can. Time is short and help is very often right "next door" in the adjacent team pits.

Small, bench-top machinery, with appropriate guards, is permitted in team pits. 'Small' machinery is machinery that can be easily lifted by one person and examples include, but are not limited to: 3D printers, small band saws, small drill presses, desktop CNC mills, and sanders.

- E501** ***Pits are unavailable if closed.** Teams may not access their pit area outside the designated pit hours.
- E502** ***Stay in your pit.** Teams may neither allow their materials to expand beyond their team pit (including running power or internet lines from their team pit to any other area), swap team pits with other teams, nor move themselves to empty team pits without Event Director approval.
- E503** ***Keep aisles clear.** Aisles must be kept clear.
- E504** ***No sparks.** Tools that throw sparks or produce open flames are prohibited.

Examples of tools that violate this rule include, but are not limited to welders, bench and angle grinders, and gas torches.

Violation: Any items that are deemed unsafe or outside specifications by FIRST personnel and/or the Event Director must be removed.

- E505** ***Nothing too big.** Floor standing power tools are prohibited.

Examples include but are not limited to full-size drill presses, and band saws.

Violation: Teams will be asked to remove or not bring in floor standing power tools. Any items that are deemed unsafe or outside specifications by FIRST personnel and/or Event Director must be removed.

- E506** ***No brazing or welding.** Brazing/welding is prohibited.

Violation: Teams will be asked to remove or not bring in brazing/welding tools. Any items that are deemed unsafe or outside specifications by FIRST personnel, and/or Event Director must be removed.

- E507** ***Solder with specific tools only.** Soldering may be done using an electric iron/gun only.

Violation: Any items that are deemed unsafe or outside specifications by FIRST personnel and/or the Event Director must be removed.

- E508** ***Structures must be safe.** Teams may not build any structure that supports the weight of people or stores items overhead. Structures may not block or inhibit fire sprinkler systems or otherwise be unsafe.

Violation: Any pit structures that are deemed unsafe or outside specifications by FIRST personnel and/or the Event Director must be removed.

- E509** ***Secure team identification assets.** Team signs, flags, and displays must be securely mounted to the pit structure.

Violation: Any pit structures that are deemed unsafe or outside specifications by FIRST personnel and/or the Event Director must be removed.

- E510** ***Only use aerosol or other chemicals with noxious fumes in approved areas.** Any aerosol or chemical that produces noxious fumes or spray particulates should only be used in approved areas. Not all venues will allow the use of these products anywhere on site.

Violation: Any items that are deemed unsafe or outside specifications by FIRST personnel and/or the Event Director must be removed.

5.6 ROBOT Carts

Most teams use carts to transport their ROBOT throughout an event. Carts are not required but are strongly recommended (to minimize risk of muscle strains, dropped ROBOTS, and other hazards). In addition to the rules listed below, teams are strongly encouraged to put the team's number on the cart, refer to the [FIRST Safety Manual](#) for ROBOT lifting techniques, and practice putting the ROBOT on and off the cart to develop a safe, quick, fluid routine.

- E601** ***Carts must be safe and easy to use.** Carts must be easy to control, maneuver, and pose no risk to bystanders.
- E602** ***Carts should not be too big.** Carts must fit through a standard 30-inch door.
- E603** ***Carts cannot park anywhere.** Carts must remain in the team pit (or other venue designated cart staging areas) when not in use.
- E604** ***No noisy carts.** Carts may not be equipped with music or other sound-generating devices.
- E605** ***No motor driven carts.** ROBOT carts may not use powered propulsion.

5.7 Ceremonies

At most events, there are opening and closing ceremonies to show honor and respect for represented countries, sponsors, teams, mentors, volunteers, and award winners. Ceremonies provide everyone with the opportunity to collectively applaud the successes of all participants. They also give teams a chance to "meet" the volunteers and other people and sponsors involved with the event. Closing ceremony elements are at the end of most events and are integrated into and presented between playoff MATCHES.

At the awards ceremony, *FIRST* presents trophies and medallions to outstanding teams. All team members are encouraged to attend the ceremonies, be punctual, and show appreciation to volunteers that staffed the event.

- E701** ***Quiet in the pits during ceremonies.** During ceremonies outside of playoff MATCHES, team members may not:
 - A. use power tools
 - B. use loud hand tools (hammers, saws, etc.)
 - C. shout, yell, or use loud voices, unless as a demonstration of approval during a ceremonial activity.
- E702** ***Pit person limit during ceremonies is 5.** No more than 5 team members may be in the pits during ceremonies outside of playoff MATCHES. Each team must have at least 1 representative observing ceremonies to be responsible to relay important information to the entire team.

All teams are encouraged to have as many people in the stands for ceremonies as possible. This is important both to celebrate all who are recognized during ceremonies, but also to listen for important day-of information from event organizers which might be critical for your team.

- E703** ***Be respectful during anthems.** Team members, including any remaining in the pits, should exhibit peaceful behavior during the presentation of all national anthems. Traditionally, team members stand to face the flag, remove hats, and either sing along or maintain a respectful silence during the anthems of all nations present at the event. If team members wish to abstain, they have a right to do so, as long as they remain silent and non-disruptive.

5.8 In the Stands

E801 *No saving seats. Teams are not permitted to save or designate seats for team members that are not actively using them.

Teams may not hang banners or ribbons or otherwise designate seating. (Event staff will remove and discard any banners, roping, etc., used to designate seating.) Please take turns sitting in the bleachers/stands if seating is limited. If there is a crowding problem, we ask that you kindly leave after your team's MATCH and return later, if possible.

The Event Director may reserve seats for attendees who require accessible seating, for certain volunteers, or to ensure teams in the playoffs have seats to watch their teams play.

E802 *No throwing items from the stands. Items may not be thrown from audience seating.



6 Awards (A)

FIRST Tech Challenge celebrates the excitement of competition both on and off the field. Through the following awards, we celebrate the FIRST Core Values which makes us so much #morethanrobots. Please note that different event types (e.g., League Tournaments, Regional Championship, FIRST Championship) or event sizes may offer different sets of awards. Not every award is presented at every FIRST Tech Challenge event. No awards are presented at League Meets, see section [14 League Play Tournaments \(L\)](#), additional details by event type are available in the sections below.

Judged awards are determined by volunteers from the community who prepare for the event with thorough training and certification. There are 2 key judging volunteer roles:

- JUDGES – meet with teams to learn about and celebrate the unique journey and accomplishments of each team and evaluate these against award requirements. JUDGES interact with STUDENTS during the interview process, and in the pits. As a group, JUDGES determine the teams that receive awards at events.
- JUDGE advisor (JA) – trains, directs, and supervises JUDGES throughout the event. JUDGE advisors oversee the judging processes and procedures to make sure they are in accordance with FIRST Tech Challenge judging guidelines.

FIRST Tech Challenge judging is delivered in one of two ways. Most events will have in-person (“traditional”) judging along with the standard in-person gameplay. The second is hybrid format which has in-person gameplay, but judging is done remotely before in-person gameplay. This manual will primarily describe the traditional in person judging process. The remote judging process follows the same overall judging standards and requirements, but interviews are conducted online, and no face-to-face meetings are required.

Teams may also read the [Judge and Judge Advisor Manuals](#) to gain more insight into the complete judging process.

6.1 Team Judged Awards Overview and Schedule

Most FIRST Tech Challenge awards fall into two broad categories: Machine, Creativity, and Innovation (MCI), and Team Attributes (TA), with two additional special awards: Inspire and Think (Figure 6-1).

Figure 6-1: Award hierarchy



- **MCI awards** recognize the technical accomplishments of teams in the planning, design, construction, operation, and control of their ROBOTS.
- **TA awards** recognize teams who have developed strong partnerships with their community. This includes recruiting members, fund-raising, and the teams’ outreach efforts to spread *FIRST*’s message about the benefits that can come from the study of math, science, and technology.
- The **Think Award** recognizes teams who masterfully document their team’s process and product using their PORTFOLIO.
- The **Inspire Award** recognizes teams who excel in MCI, TA, and Think award accomplishments. This team is an all-around inspiration for others

The JUDGES will gather information from the teams through several different pathways (Figure 6-2). All teams will have the opportunity to submit a written PORTFOLIO which should document aspects of their teams which directly support the judged award criteria or information which they wish the JUDGES to consider. All teams are encouraged to prepare for a judging interview session where the team can present a prepared oral presentation to a small panel of JUDGES about their team followed by a Q&A session. After all the judging panels have finished, the JUDGES compare notes and may elect to follow up with the teams in the pit area during the competition and conduct more informal pit interviews. JUDGES may also accept feedback about teams at the event from other event volunteers to help inform their understanding of the team.

Figure 6-2: Sources of information for Judged Awards

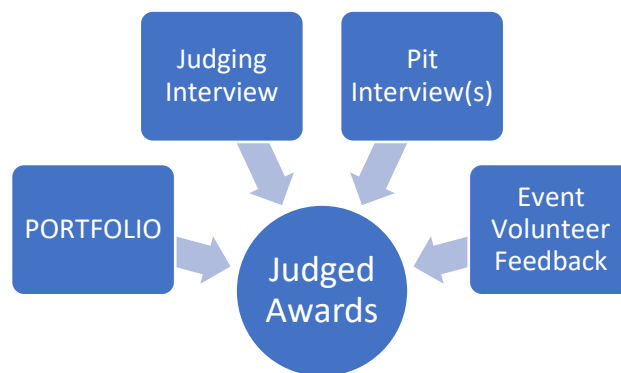

In addition to the specific information sources JUDGES use to evaluate teams, there are also sources of information which are specifically disallowed. JUDGES are strictly instructed to only consider information from the current event and the current season and cannot consider information from outside what they have seen or heard at the current event. This means that information like past performance (good or bad), personal knowledge of a team, and external sources like websites and social media are not considered. JUDGES also do not consider overall ROBOT performance in an award unless it is specifically listed as part of the required or encouraged evaluation criteria.

The awards are a method *FIRST* uses to inspire STUDENTS and open their eyes to building a better future together. The awards process should foster a positive STUDENT interaction with JUDGES who are successful professionals and can recognize their achievements and encourage them to continue learning.

All award winners chosen by the JUDGES are recognized as being positive examples of the award guidelines, not necessarily the “best” team.

Teams may participate in judging regardless of the inspection status of their ROBOT and are eligible for awards even if they are attending the event without a ROBOT.

A101 *Team PORTFOLIOS have limits. Teams have the opportunity to submit a team PORTFOLIO to be used as part of the judging process. No other printed or digital content not directly included in this document will be collected by the JUDGES to consider during deliberations. PORTFOLIOS must meet the following requirements:

- A. must consist of 1 cover page including the team number and optionally: team name, PORTFOLIO table of contents, team organizations, sponsors, logo, motto, and picture of the ROBOT and/or team.
- B. no more than 15 pages of judged content (if printing front and back, 8 sheets of paper, including the cover page)
- C. use only US Letter (8.5" x 11") or A4 (210 x 297 mm) size paper.
- D. font minimum of 10 point or larger
- E. if submitted digitally, the complete submission must be less than 15MB in size.
- F. must only include progress, challenges, and accomplishments which take place during the current season and, for returning teams, after the conclusion of their last official event that they participated in.

None of the content of the cover page will be used by JUDGES to evaluate any awards criteria. Any content beyond the allowed 15 pages will not be reviewed by the JUDGES.

The JUDGES use the cover page to identify the team associated with the PORTFOLIO. Teams who forget to include a cover page may be disqualified from judging if the JUDGES cannot determine what team the PORTFOLIO is associated with.

Font minimums are used to help ensure minimum readability. Teams should carefully consider font size, color, and graphic design when making their PORTFOLIO so that all JUDGES are able to read their submission. Teams whose design choices include small fonts or low contrast text on images will not be excluded from consideration but understand that JUDGES will not be able to use anything they cannot read.

JUDGES will not open, view, or use any included links to other documents, websites, or videos referenced to linked to from the PORTFOLIO.

Teams may use writing and research aids including Artificial Intelligence (AI) to help them compose their PORTFOLIOS. If AI or other resources are used, they must be credited via footnote or endnote.

The PORTFOLIO captures a team's progression through the current *FIRST* Tech Challenge season. A team may include anything in their PORTFOLIO which took place after their final official event of the previous season. Off-season events are not a part of the official *FIRST* Tech Challenge event calendar may be included as part of the team's current season. A team may reference previous seasons (for example, in a team or organizational plan) to demonstrate growth, but the emphasis must be on the current season.

A102 *PORTFOLIOS must be submitted on time as requested. To be considered as part of the judging process a team must submit their PORTFOLIO as instructed by the Event Director and by the stated deadline. If no other instructions are provided, teams should submit 1 printed copy of their PORTFOLIO during the judging interview.

Instructions about when and how teams should submit their PORTFOLIOS should be communicated by the Event Director before the event.

If circumstances prevent a team from following the PORTFOLIO submission instructions, the Event Director should work with the JUDGE advisor to make reasonable accommodations to accept all team PORTFOLIOS unless doing so poses an undue burden to the judging process.

A103 *Teams must attend a judging interview session. To be considered for any judged awards the team must attend their assigned judging interview session.

Teams should be informed of their assigned time by the Event Director or local Program Delivery Partner in advance of the event. If there is a schedule conflict or the team misses their interview slot due to unforeseen circumstances the team should work with the Event Director or local Program Delivery Partner to make alternate accommodations for a judging interview at the event if possible.

A104 *Bring the right resources with you to your judging interview. Teams attending their judging interview time slot should come prepared with the following:

- A. no less than 2 STUDENT representatives for teams of 2 STUDENTS and larger,
- B. a copy of their team PORTFOLIO (optional, submit as instructed by the Event Director)
- C. “show and tell” demonstration items which may include the team’s ROBOT (encouraged, but optional)
- D. 1 silent observer per [A108](#) (optional)
- E. 1 support person to fill accommodations needs per [A109](#) (optional, as needed)

Teams are encouraged to have as many STUDENTS as possible involved in the judging interview process.

A team does not have to have a ROBOT to participate in judging or be eligible for judged awards. If the team brings a ROBOT to present to the JUDGES it does not have to be inspected but should be built to be compliant with the current season’s FIRST Tech Challenge ROBOT construction rules and designed to play this season’s game.

A105 *Everyone gets equal judging interview time. All teams will be scheduled for the same length judging interview of at least 10 minutes with a minimum of 10 minutes reserved between judging interviews for JUDGES to confer.

A106 *The judging interview timer starts when the team starts. The timer starts after the team has entered the room and when they begin their presentation. Teams who take an extended amount of time to begin will be warned by the JUDGES to begin promptly and then the judging interview timer will be started regardless of the readiness of the presenting team.

Teams should enter the room and prepare to begin speaking in an expedited manner. This rule is aimed at letting large teams get lined up and oriented in the

room and for the JUDGES to introduce themselves and provide reminders of the interview format.

Do not attempt to abuse the delayed start timer to set up equipment or otherwise gain an advantage.

A107 *Prepared formal presentation time should not be interrupted. The first 5 minutes of the judging interview are reserved for the team to present a prepared oral presentation uninterrupted, if they choose. The uninterrupted presentation time may be ended early by the team. Any remaining time should be a back-and-forth question and answer-type conversation with the STUDENTS and led by the JUDGES.

A108 *One adult silent observer is welcome. One adult mentor may attend the judging session and be present for any interaction between the JUDGES and the STUDENT team members. Adult mentor(s) may be present for any interactions between the JUDGES and the STUDENT team members outside of the formal scheduled interview. The adult observer and mentor(s) may not interact or coach actively during any interaction between the JUDGES and the STUDENT team members.

The purpose of the adult silent observer is to provide silent confidence to the STUDENT team members presenting in an unknown environment with new people. The adult observer can also provide coaching and feedback to their team following the conclusion of the judging interview and outside of the designated judging space.

A109 *Translator accommodations will be made for teams who need it. Teams who need to use a translator to communicate with the JUDGE panel may provide one if the team's native language does not match that of the event host site provided JUDGES. This includes sign language or other adaptive technology. Teams who intend to interview with the assistance of a translator should work with the Event Director in advance to request additional interview time of between 2 and 5 minutes. The translator may be an adult and can be in addition to the silent observer in [A108](#).

A110 *No Video or Audio recording during judging interview. In addition to the restrictions of [E117](#), teams may not record any video or audio during their judging interview.

A111 *The number of awards given scales with event size. Total number of awards given is based on the number of teams checked in at the event. Not all awards are given at every competition. Check the [Judge and Judge Advisor Manuals](#) for exact details.

Table 6-1: Total judged awards available based on all event participating teams

		Total Event Participating Teams			
Award		4-10 Teams	11-20 Teams	21-40 Teams	41-64 Teams
Inspire Award		1 st Place	1 st Place 2 nd Place	1 st Place 2 nd Place 3 rd Place	1 st Place 2 nd Place 3 rd Place
Think Award		1 st Place	1 st Place	1 st Place 2 nd Place	1 st Place 2 nd Place (3 rd Place*)
TA Awards	Connect Award	1 st Place (1 TA award will be given)	1 st Place	1 st Place (2 nd Place*)	1 st Place 2 nd Place (3 rd Place*)
	Motivate Award		1 st Place	1 st Place (2 nd Place*)	1 st Place 2 nd Place (3 rd Place*)
MCI Awards	Design Award	1 st Place (1 MCI award will be given)	1 st Place	1 st Place (2 nd Place*)	1 st Place 2 nd Place (3 rd Place*)
	Innovate Award		1 st Place	1 st Place (2 nd Place*)	1 st Place 2 nd Place (3 rd Place*)
	Control Award		1 st Place	1 st Place (2 nd Place*)	1 st Place 2 nd Place (3 rd Place*)

*Discretionary awards

See section [13.7 Dual Division Events](#) for the modified dual division version of this rule.

A112 *Judging feedback is provided to all teams. All teams will receive feedback from their judging interview session. The JUDGES complete a form immediately following the interview based on their initial impression of the team. This feedback form is not used during deliberations and does not include any updated feedback based on later interactions by the JUDGES with the team.

The feedback form will either be returned with the PORTFOLIO for in-person judging or the Lead Coach/Mentor 1 will receive access to a digital version following the event in the case of remote judging.

A113 *Teams are only eligible to win the Inspire Award in their own region. Teams are only eligible to be considered for the Inspire Award (1st, 2nd or 3rd place) when competing at a tournament within their own region.

A114 *Teams cannot win the Inspire Award at multiple Qualifying or League Tournaments. Teams are only eligible to win 1st place Inspire Award once per season from any Qualifying or League Tournament. Teams who have won 1st place Inspire may not be considered for 1st, 2nd, or 3rd place Inspire at subsequent Qualifying or League Tournaments.

6.2 Team Judged Award Descriptions

6.2.1 Inspire Award

The team that receives this award is a strong ambassador for *FIRST* programs and a role model *FIRST* team. This team is a top contender for many other judged awards and is a gracious competitor.

The Inspire Award winner is an inspiration to other teams, acting with Gracious Professionalism® both on and off the playing FIELD. This team shares their experiences, enthusiasm and knowledge with other teams, sponsors, their community, and the JUDGES. Working as a unit, this team will have shown success in performing the task of designing and building a ROBOT.

Table 6-2: Inspire Award Criteria

Inspire Award Criteria		
Required	1	Team must submit a PORTFOLIO. The PORTFOLIO must include engineering content, team information and a team plan. The PORTFOLIO must be high quality, thoughtful, thorough, and concise.
Required	2	The Inspire Award celebrates the strongest qualities of all the judged awards. A team must be a strong contender for at least one award in each of the following judged award categories: A. Machine, Creativity, and Innovation Awards, B. Team Attributes Awards, and C. Think Award
Required	3	Team must be positive and inclusive, and each team member contribute to the success of the team.
Encouraged	4	The team should be able to discuss, demonstrate, display, document, or otherwise provide more detailed information to support the information in the PORTFOLIO.

6.2.2 Think Award

Removing engineering obstacles through creative thinking.

This judged award is given to the team that best reflects the journey the team took as they experienced the engineering design process during the build season. The engineering content within the PORTFOLIO is the key reference for JUDGES to help identify the most deserving team. The team could share or provide additional detailed information that is helpful for the JUDGES.

Table 6-3: Think Award Criteria

Think Award Criteria		
Required	1	Team must submit a PORTFOLIO. The PORTFOLIO must include engineering content which includes at least one of the following: <ul style="list-style-type: none"> A. evidence of use of the engineering process, B. lessons learned, C. trade off analysis /cost benefit analysis, and/or D. mathematical analysis used to make design decisions
Encouraged	2	Team should be able to discuss, describe, display, or document the engineering content contained in their PORTFOLIO during the judging interview and/or pit interviews.
Encouraged	3	Team PORTFOLIO may include information about technical resources which includes any number of the following examples: <ul style="list-style-type: none"> A. how the team acquire new mentors, B. how the team learns from team mentors, and/or C. development plan for team members to learn new skills
Encouraged	4	PORTFOLIO information is organized in a clear and intuitive manner

6.2.3 Connect Award

Connecting the dots between the STEM community, FIRST, and the diversity of the engineering world.

This judged award is given to the team that connects with their local science, technology, engineering, and math (STEM) community. A true FIRST team is more than a sum of its parts and recognizes that engaging their local STEM community plays an essential part in their success. This team has a team plan and has identified steps to achieve their goals. A PORTFOLIO is not required for this award.

Table 6-4: Connect Award Criteria

Connect Award Criteria		
Required	1	Team must describe, display, or document a team plan that covers all of the following: <ul style="list-style-type: none"> A. The team’s goals for the development of team member skills, and B. The steps the team has taken or will take to reach those goals
Encouraged	2	Provide examples of developing in person or virtual connections with individuals in the engineering, science, or technology community.
Encouraged	3	Provide examples of how it actively engages with the engineering community.

6.2.4 Motivate Award

Sparking others to embrace the culture of STEM through FIRST!

This team embraces the culture of *FIRST* and shows what it means to be a team. This team makes a collective effort to make *FIRST* known throughout their school and community and sparks others to embrace *FIRST*'s culture. A PORTFOLIO is not required for this award.

Table 6-5: Motivate Award Criteria

Motivate Award Criteria		
Required	1	Team must describe, display, or document an organizational plan which includes at least one of the following examples: A. team or organization goals, B. finances and financial sustainability plan, C. risk management planning, D. season timeline project planning, and/or E. outreach and service plan
Required	2	Discuss, describe, display, or document the individual contributions of each team member, and how these apply to the overall success of the team.
Encouraged	3	Is an ambassador for <i>FIRST</i> programs and successfully recruits people who were not already active within the STEM community.
Encouraged	4	Evidence of using lessons learned from outreach activities to improve future events.
Encouraged	5	Has a creative approach to materials that market their team and <i>FIRST</i> .

6.2.5 Innovate Award sponsored by RTX

Bringing great ideas from concept to reality.

The Innovate Award celebrates a team that thinks imaginatively and has the ingenuity, creativity, and inventiveness to make their designs come to life. This judged award is given to the team that has an innovative and creative ROBOT design solution to any specific components in the *FIRST* Tech Challenge game. Elements of this award include design, robustness, and creative thinking related to design. This award may address the design of the whole ROBOT or of a MECHANISM attached to the ROBOT and does not have to work all the time during matches to be considered for this award. A PORTFOLIO is not required for this award.

Table 6-6: Innovate Award Criteria

Innovate Award Criteria		
Required	1	Team must describe, display, or document examples of the team's engineering content that illustrate how the team arrived at their design solution.
Required	2	ROBOT or ROBOT MECHANISM is creative and unique in its design.
Required	3	Creative design element must be stable, robust, and contribute positively to the team's game objectives most of the time.
Encouraged	4	Creative designs often come with additional risks, the team should document or describe how they mitigated that risk.

6.2.6 Control Award

The Control Award celebrates a team that uses sensors and software to increase the ROBOT’S functionality during gameplay. This award is given to the team that demonstrates innovative thinking and solutions to solve game challenges such as autonomous operation, improving mechanical systems with intelligent control, or using sensors to achieve better results. The solution(s) should work consistently during MATCHES. The team’s PORTFOLIO must contain a summary of the software, sensors, and mechanical control but would not include copies of the code itself.

Table 6-7: Control Award Criteria

Control Award Criteria		
Required	1	Team must submit a PORTFOLIO. The PORTFOLIO must include all of the following: A. hardware and/or software control COMPONENTS on the ROBOT, B. which challenges each COMPONENT or system is intended to solve, and C. how does each COMPONENT or system work
Required	2	Team must use one or more hardware or software solutions to improve ROBOT functionality by using external feedback and control.
Encouraged	3	The control solution(s) should work consistently during most MATCHES.
Encouraged	4	Team could describe, display, or document how the solution should consider reliability either through demonstrated effectiveness or identification of how the solution could be improved
Encouraged	5	Use of the engineering process to develop the control solutions (sensors, hardware and/or algorithms) used on the ROBOT includes lessons learned.

6.2.7 Design Award

The Design Award celebrates the team that demonstrates industrial design principles, striking a balance between form, function, and aesthetics. The design process used should result in a ROBOT which is efficiently designed, and effectively addresses the game challenge. A PORTFOLIO is not required for this award.

Table 6-8: Design Award Criteria

Design Award Criteria		
Required	1	A team must be able to describe or demonstrate how their ROBOT is elegant, efficient (simple/executable), and practical to maintain.
Required	2	The entire machine design, or the detailed process used to develop the design, is worthy of this recognition, and not just a single COMPONENT.
Encouraged	3	The ROBOT distinguishes itself from others by its aesthetic and functional design.
Encouraged	4	The basis for the design is well considered (that is inspiration, function, etc.).
Encouraged	5	Design is effective and consistent with team’s game plan and/or strategy.

6.2.8 Judges' Choice Award

This award is optional and not given at all *FIRST* Tech Challenge events.

During the competition, the judging panel may meet a team whose unique efforts, performance, or dynamics merit recognition, but does not fit into any of the existing award categories. To recognize these unique teams, *FIRST* offers a Judges' Choice Award.

The Judges' Choice Award recognizes a team for their outstanding efforts but does not factor into the advancement criteria.

6.3 Tournament ALLIANCE Awards

6.3.1 Winning Alliance Award

This award will be given to the winning ALLIANCE represented in the final MATCH of the playoffs of a single-division Tournament or Championship event. If the event is a dual-division or multi-division event, there will be Winning Alliance Awards awarded to both the division playoff winner and the event finals playoff winner.

6.3.2 Finalist Alliance Award

This award will be given to the finalist ALLIANCE represented in the final MATCH of the playoffs of a single-division Tournament or Championship event. If the event is a dual-division or multi-division event this will be awarded to the division playoff finalist and the event finals playoff finalist.

6.4 Individual Awards

6.4.1 Dean's List Award

In an effort to recognize the leadership and dedication of the most outstanding secondary school STUDENTS from *FIRST*, the Kamen family sponsors awards for selected 10th or 11th grade STUDENTS known as the *FIRST* Tech Challenge *FIRST* Dean's List Award.

The STUDENTS who earn *FIRST* Dean's List status as a semi-finalist, finalist or winner, are great examples of current STUDENT leaders who have led their teams and communities to increased awareness for *FIRST* and its mission. It is the goal of *FIRST* that these individuals will continue, post-award, as great leaders, STUDENT alumni, and advocates of *FIRST*.

For more information on the Dean's List Award, and to see past *FIRST* Tech Challenge winners, please visit our [website!](#)

For regions of the world that do not use grade levels such as this to identify years of schooling: This award is intended for STUDENTS who are two (2) to three (3) years away from entering college or university. STUDENTS that would be attending college or university in the next academic year are not eligible. Mentors will be asked for the year of graduation during the nomination process.

6.4.2 Compass Award

This is an optional award and is only offered at the Regional Championship tournament level of competition. All teams attending *FIRST* Championship will have an opportunity to submit for this award.

The Compass Award recognizes an adult coach or mentor who has given outstanding guidance and support to a team throughout the year and demonstrates to the team what it means to be a Gracious Professional. The winner of the Compass Award will be chosen from candidates nominated by FIRST Tech Challenge STUDENT team members, via a 40-60 second video submission. The video must highlight how their mentor has helped them become an inspirational team. The video should emphasize what sets the mentor apart.

Table 6-9: Compass Award Criteria

Compass Award Criteria		
Required	1	Team must be able to clearly articulate this mentor’s contribution to the team and explain what sets this mentor apart.
Required	2	<p>Submission must be in video format and meet the following requirements:</p> <ul style="list-style-type: none"> A. submitted by the deadline established by the Event Director or local Program Delivery Partner instructions B. be in one of the following formats: .mp4, .mov, .avi, or .wmv (no links to streaming services will be accepted) C. one video submission per team per event (videos can be updated or changed between events) D. all music must be used with permission from the copywrite owners and be indicated in the video credits E. videos cannot be longer than 60 seconds, including credits

Teams are encouraged to review the [FIRST Branding and Style Guidelines](#) before creating their video.



7 Game Sponsor Recognition



8 Game Overview

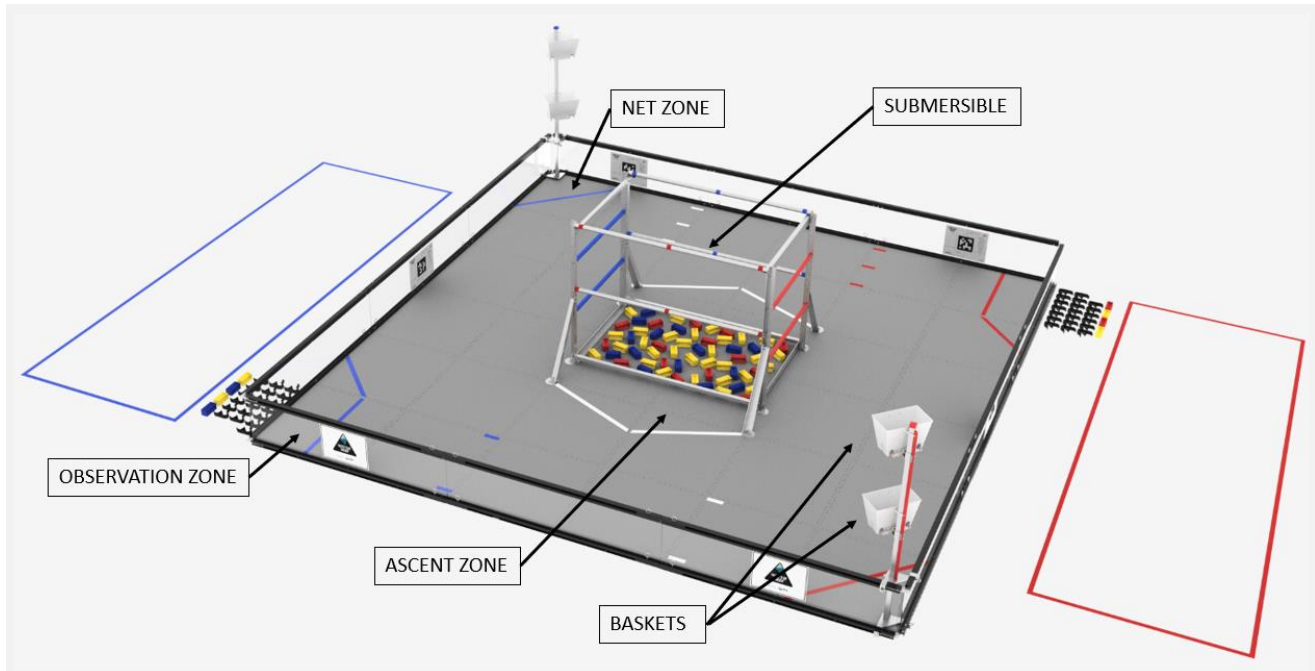

In INTO THE DEEPSM presented by RTX, two competing ALLIANCES collect deep sea SAMPLES to score in their NET ZONE or BASKETS, work with HUMAN PLAYERS to create SPECIMENS to score on the CHAMBERS of the SUBMERSIBLE and ASCEND from the depths before time runs out.

During the first 30 seconds of the MATCH the ROBOTS operate autonomously. Without guidance from their drivers, the ROBOTS score SAMPLES in their BASKETS or NETS, or SPECIMENS on the CHAMBERS. They can collect additional SAMPLES to score in BASKETS or make into SPECIMENS and PARK before the end of the period.

During the remaining 2 minutes of the MATCH, human drivers take control of their ROBOT. ROBOTS collect and sort SAMPLES from under the SUBMERSIBLE in the center of the FIELD. The yellow SAMPLES are scored in the BASKETS and the ALLIANCE SPECIFIC (i.e., elements owned or associated with a specific ALLIANCE) red and blue SAMPLES are returned to the OBSERVATION ZONE for the HUMAN PLAYERS to collect.

HUMAN PLAYERS can pick up SAMPLES delivered to the OBSERVATION ZONE and add a hanging CLIP to create a SPECIMEN. SPECIMENS can then be returned to the OBSERVATION ZONE on the FIELD where ROBOTS can pick them back up and score them on the CHAMBERS located on the SUBMERSIBLE.

As time runs out, ROBOTS can either PARK in the OBSERVATION ZONE or race back to climb the RUNGS on the SUBMERSIBLE so they can ASCEND out of the deep.

The ALLIANCE that earns the most points wins the MATCH!



9 ARENA

The ARENA includes all elements of the game infrastructure that are required to play INTO THE DEEP: the FIELD, SCORING ELEMENTS, queue area, team media area, and all equipment needed for event management.

Figure 9-1 INTO THE DEEP ARENA (queue area, field display, and optional media area not pictured)

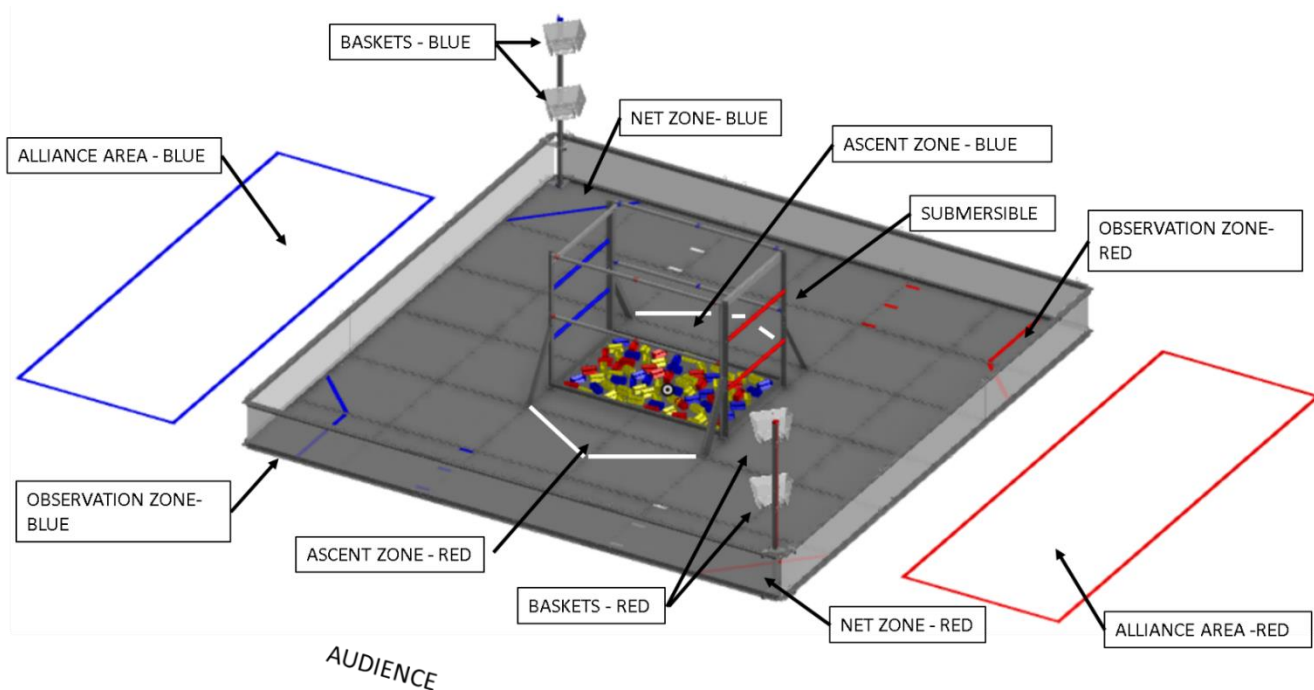

The ARENA is modular and is assembled, used, disassembled, and transported many times during the competition season. It undergoes wear and tear. The ARENA is designed to withstand rigorous play and frequent reassembly. Every effort is made to ensure that ARENAS are consistent from event to event. However, ARENAS are assembled in different venues by different event staff and some small variations occur. For details regarding assembly tolerances, please refer to the ARENA Layout and Marking Diagram. Successful teams will design ROBOTS that are insensitive to these variations.

Illustrations included in this section are for a general visual understanding of the INTO THE DEEP ARENA, and dimensions included in the manual are nominal. Please refer to the official drawings for exact dimensions, tolerances, and construction details. The official drawings, CAD models, and drawings for low-cost versions of important elements of the INTO THE DEEP FIELD are posted on [the Game and Season page](#) on the FIRST website.

9.1 FIELD

Each FIELD for INTO THE DEEP is an approximately 12 ft. (3.66m) by 12 ft. (3.66m) area bounded by the outside edge of the extrusion that frames the walls of the FIELD perimeter. The flooring surface of the FIELD is made of 36 (nominal) 24 in. x 24 in. x 5/8 in. interlocking soft foam TILES.

The FIELD is populated with the following elements:

- 2 BASKETS per ALLIANCE, and
- 1 SUBMERSIBLE per FIELD.

Official events use the full INTO THE DEEP FIELD manufactured and sold by AndyMark (am-5400_Full).

The surface of the FIELD is [FIRST Tech Challenge Field Soft Tiles](#) (am-2499).

There are 2 versions of FIELD perimeter used for competitions. One of the options is the IFI Field Perimeter (discontinued, 278-1501) and the other is the [FIRST Tech Challenge Perimeter Kit](#) (am-0481) sold by AndyMark. All illustrations in this manual show the am-0481 version of the FIELD design.

9.2 Areas, Zones, & Markings

FIELD areas, zones, and markings of consequence are described below. Zones identify spaces within the FIELD, while areas are spaces outside of the FIELD. Unless otherwise specified, the tape used to mark lines and zones throughout the FIELD is 1-in. (25 mm) wide [3M™ Premium Matte Cloth \(Gaffers\) Tape \(GT1\)](#), [ProGaff® Premium Professional Grade Gaffer Tape](#), or comparable gaffers tape.

Figure 9-2 Areas, markings, and zones

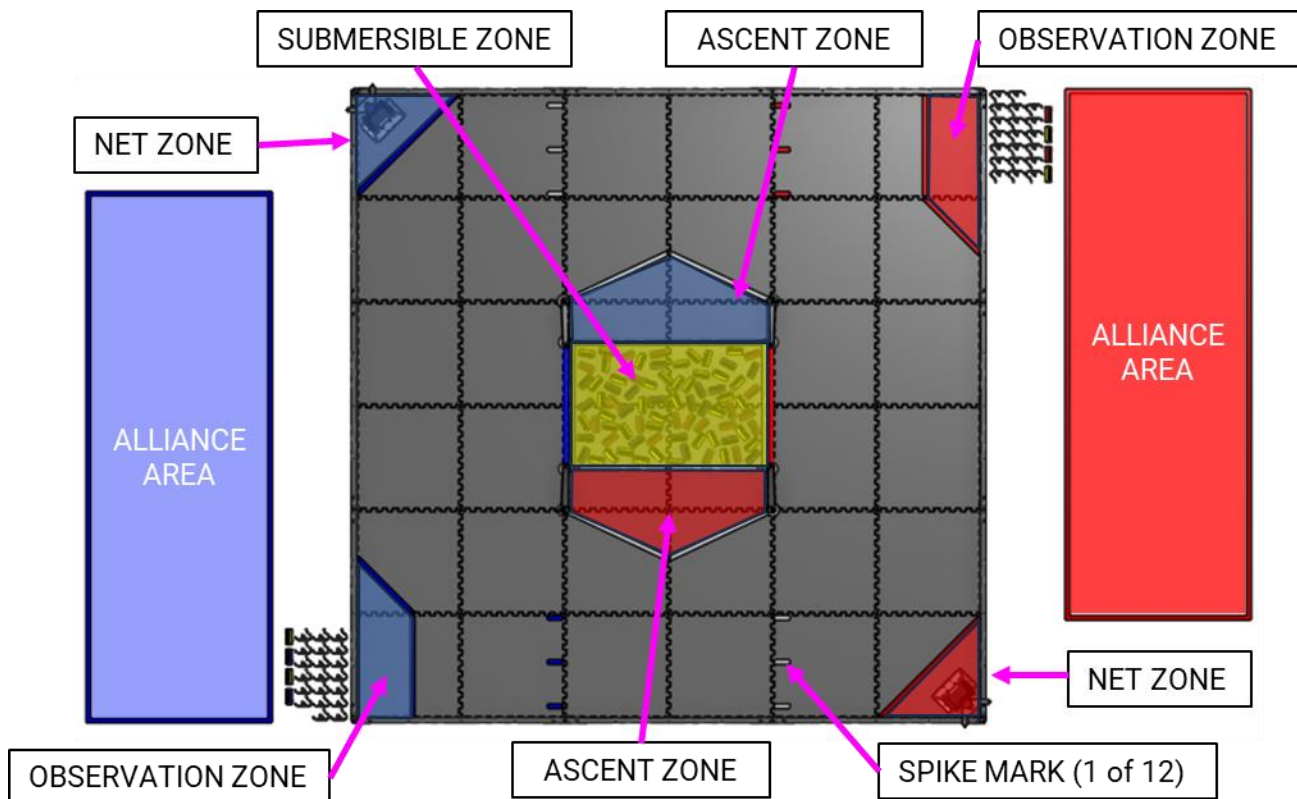

- **ALLIANCE AREA:** a 120 in. (~304.8 cm) wide by 42 in. (~106.7 cm) deep by infinitely tall volume formed by placing ALLIANCE colored tape onto the flooring surface outside of the FIELD. The ALLIANCE AREA includes the taped lines.
- **ASCENT ZONE:** an infinitely tall 5-sided polygon that is formed from two 9.25 in. (~23.5 cm) long sides bounded by the SUBMERSIBLE outriggers, one 44.75 in. (~113.7 cm) long side bounded by the barrier of the SUBMERSIBLE, and the two 26 in. (~66 cm) long sides bounded by white tape that extend from the outriggers to a point 20 in. (~50.8 cm) from the barrier. The ASCENT ZONE includes the taped lines. ASCENT ZONES are only ALLIANCE SPECIFIC ZONES during the last 30 seconds of a MATCH.
- **NET ZONE:** an infinitely tall triangle bounded by the FIELD walls located beneath the BASKETS and ALLIANCE colored tape that is diagonal from corner to corner across the TILE. The outside edge of the tape is 22.75 in. (~57.8 cm) away from the FIELD corner when measured at the FIELD wall. The NET ZONE includes the taped lines.
- **OBSERVATION ZONE:** an infinitely tall 4-sided polygon which is 36.6 in. (~92.9 cm) at the widest point by 13.1 in. (~33.3 cm) long bounded by ALLIANCE colored tape and the adjoining FIELD wall. The OBSERVATION ZONE includes the taped lines.
- **SPIKE MARK:** one of twelve 3.5 in. (~8.9 cm) long marks used to identify the placement of SAMPLES before the MATCH. The 3 marks in front of the OBSERVATION ZONES are of ALLIANCE colored tape and the 3 marks in front of each NET ZONE are made of white tape.
- **SUBMERSIBLE ZONE:** a 27.5 in. (~69.9 cm) wide by 42.75 in. (~108.6 cm) long, infinitely tall volume bounded by the inner most edge of the barriers of the SUBMERSIBLE.

9.3 TILE Coordinates

TILE coordinates are used to assist with FIELD setup. Figure 9-3 defines the intersections of each of the TILES on the FIELD where the TILE tabs interlock. Figure 9-4 defines the grid coordinate system for each of the TILES.

Figure 9-3: TILE tab-line locations

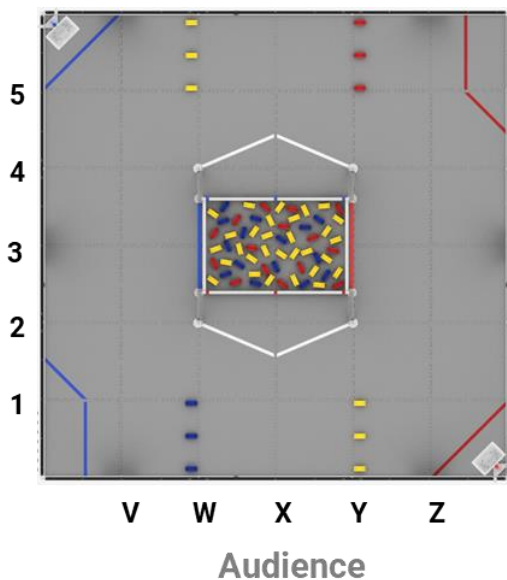
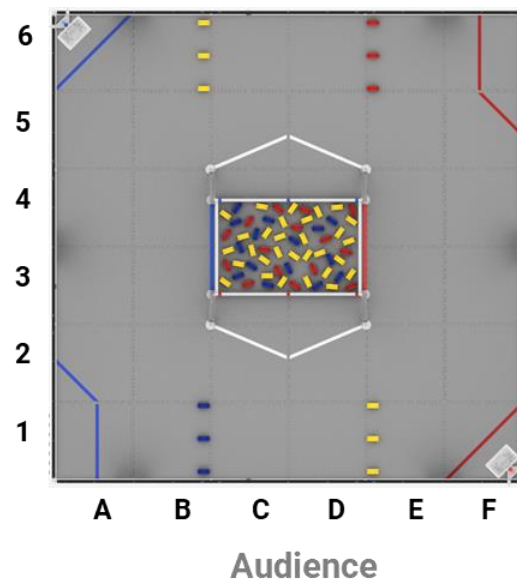

Figure 9-4: TILE locations



9.4 ALLIANCE AREA

An ALLIANCE AREA is the designated red or blue ALLIANCE AREA adjacent to the FIELD where the DRIVE TEAMS stand during a MATCH.

Short tables, stands, or stools may be provided by the event which will sit near the FIELD wall in front of or partially inside the ALLIANCE AREA. These tables are provided for teams to place their OPERATOR CONSOLES. If provided by the event these tables may not be removed or rearranged by the teams without permission from the Head REFEREE, FIELD Supervisor or FTA.

Figure 9-5: ALLIANCE AREA

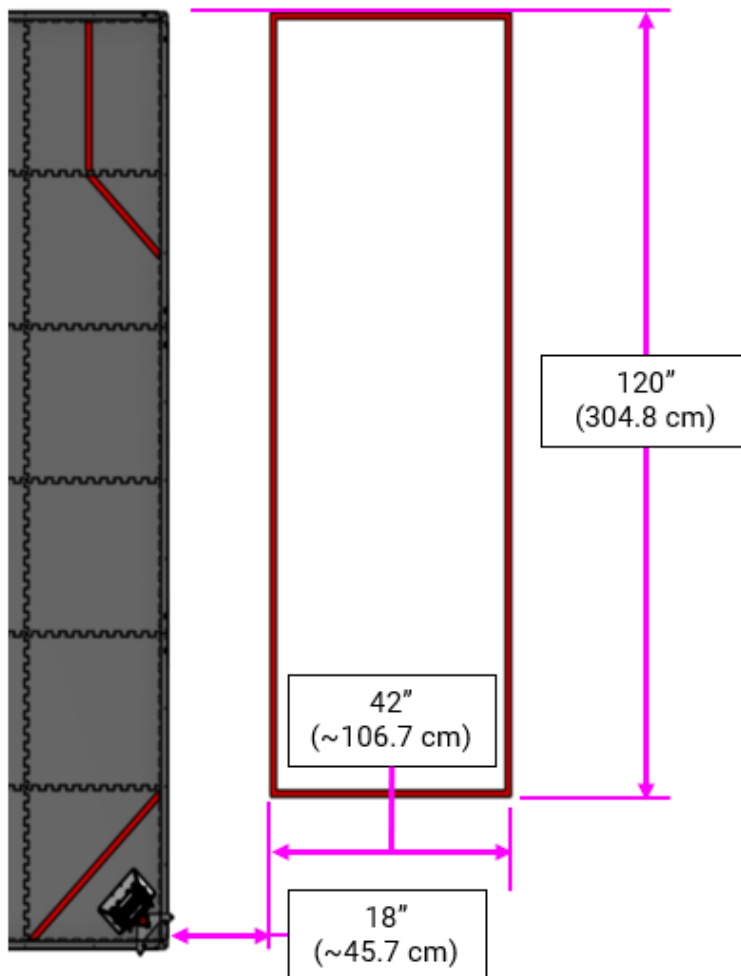

9.5 SUBMERSIBLE

A SUBMERSIBLE is a structure where ROBOTS collect SAMPLES, score SPECIMENS onto the CHAMBERS, and ASCEND using RUNGS. The SUBMERSIBLE is made up of aluminum framing, round extruded aluminum RUNGS, and High Impact Polystyrene (HIPS) plastic pipe.

The LOW CHAMBERS and HIGH CHAMBERS, made of red and blue HIPS pipes, run on opposite sides of the SUBMERSIBLE, with two red CHAMBERS facing the red ALLIANCE AREA, and two blue CHAMBERS adjacent to the blue ALLIANCE AREA.

The LOW RUNG and HIGH RUNG are round aluminum extrusions that are on the sides of the SUBMERSIBLE perpendicular to the ALLIANCE AREAS.

The approximate exterior dimensions for the SUBMERSIBLE with the outriggers are shown in Figure 9-6.

Figure 9-6: Exterior measurements of the SUBMERSIBLE

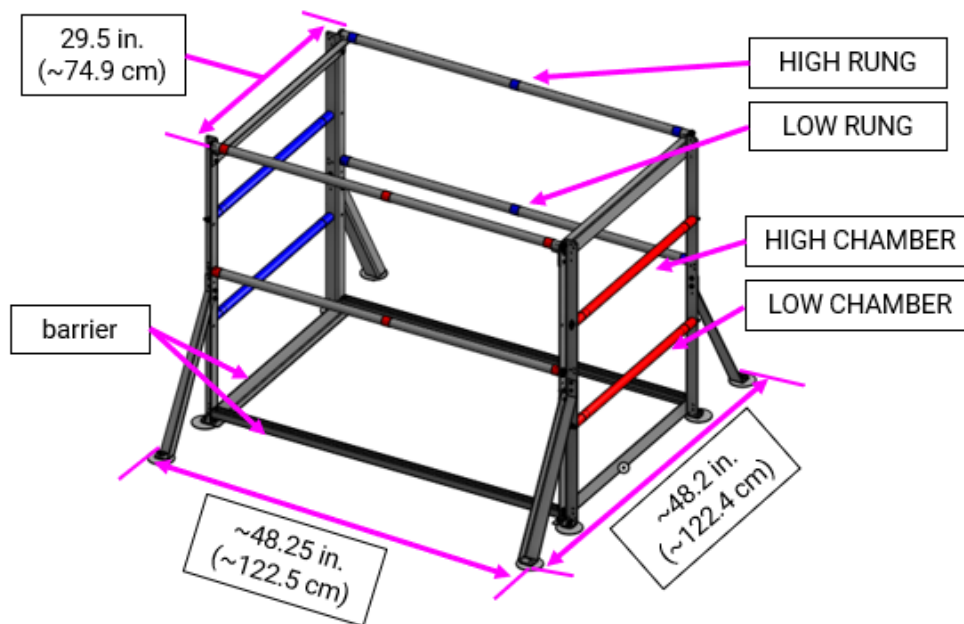
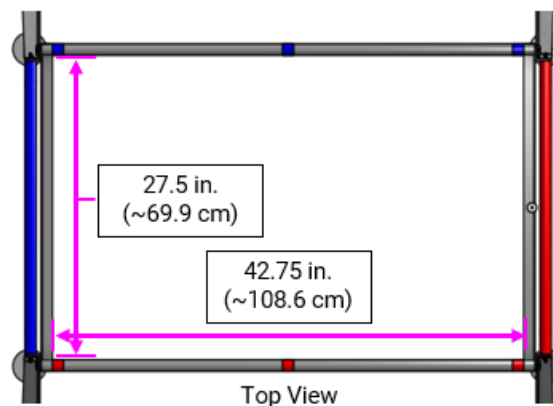

Figure 9-7: SUBMERSIBLE ZONE Measurements



9.5.1 CHAMBERS

There are two CHAMBERS per ALLIANCE in the SUBMERSIBLE. The LOW CHAMBER is made of HIPS plastic pipe and is 13 in. (~33.0 cm) from the FIELD floor to the top of the 1.05 in. (~2.7 cm) pipe. The HIGH CHAMBER is made of the same plastic pipe and is 26 in. (~66 cm) from the FIELD floor to the top of the pipe. Both the red and the blue CHAMBERS are 26.5 in. (~67.3 cm) wide and are attached to vertical metal frame of the SUBMERSIBLE.

Below the CHAMBERS and sitting on top of the FIELD TILES is a 2 in. (~5 cm) tall metal barrier. This barrier helps to keep SCORING ELEMENTS inside the SUBMERSIBLE during gameplay.

Figure 9-8: SUBMERSIBLE CHAMBERS

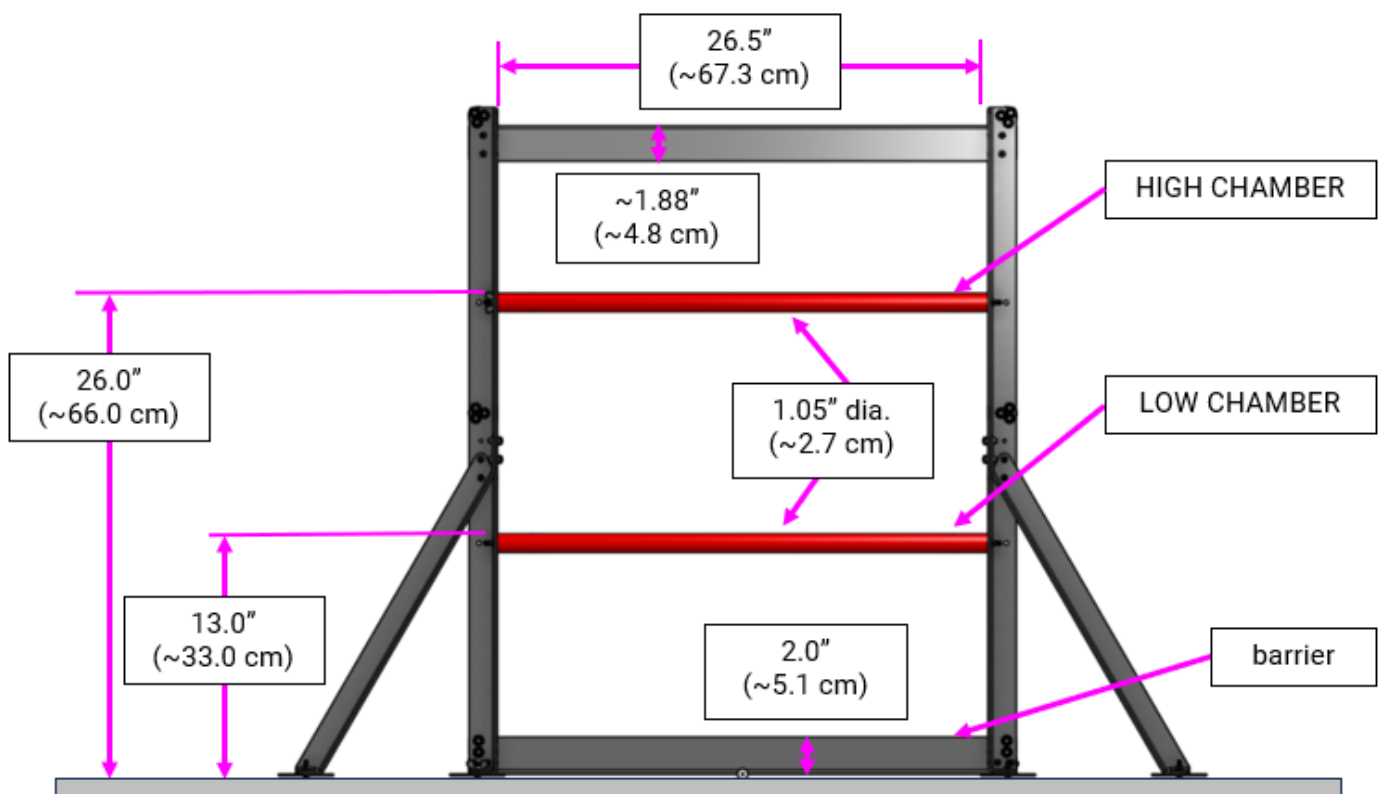

9.5.2 RUNGS

The RUNGS are 1 in. (~2.5 cm) diameter aluminum extrusion which are 44.5 in. (~113 cm) long and are attached to vertical metal extrusions that make up the SUBMERSIBLE frame. There are two different height RUNGS on either side of the SUBMERSIBLE. The top of the LOW RUNG is 20 in. (~50.8 cm) from the FIELD floor, and the top of the HIGH RUNG is 36 in. (~91.4 cm) from the FIELD floor.

There is a metal barrier below the RUNGS and above the TILES to help contain SCORING ELEMENTS.

Figure 9-9: SUBMERSIBLE RUNGS and barrier

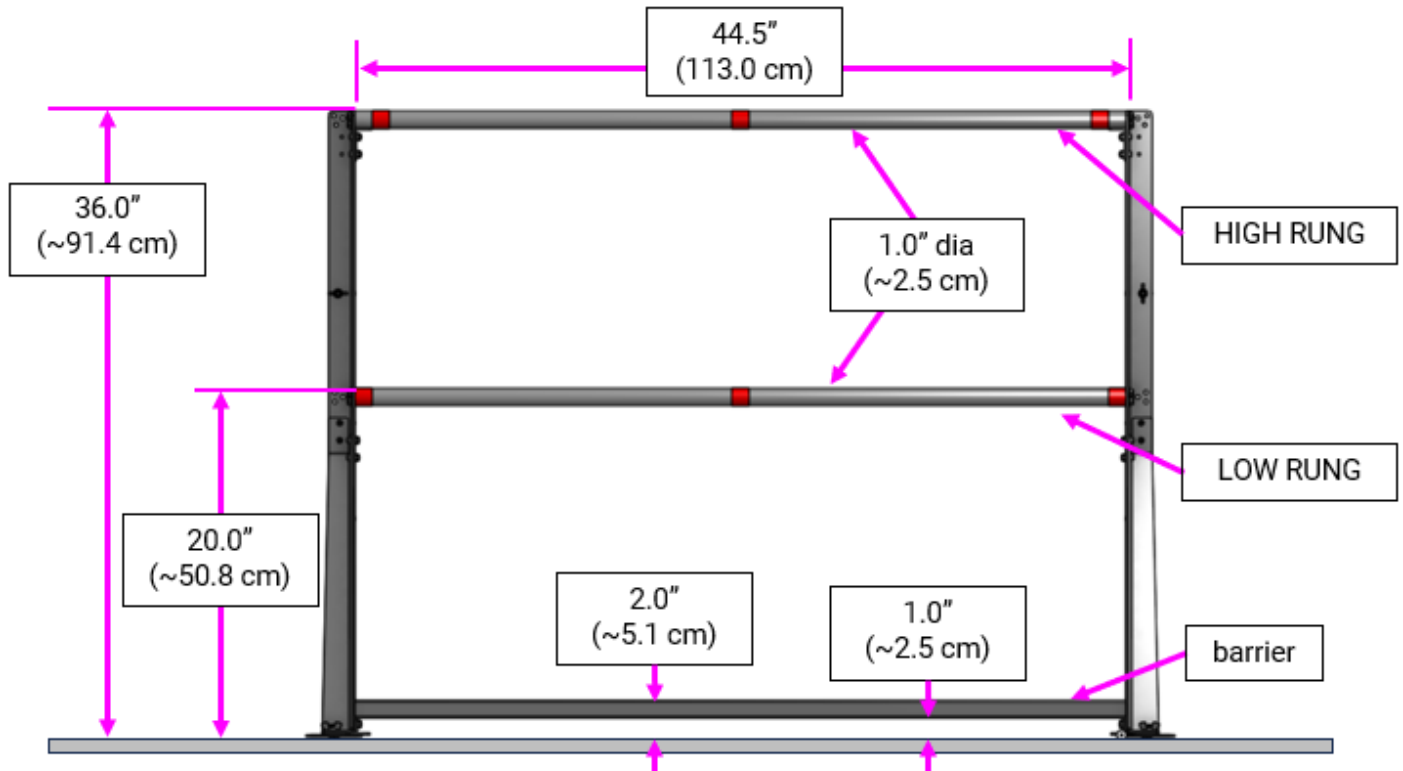

9.6 BASKETS

The BASKETS are molded plastic containers which have an 8.85 in. (~22.5 cm) wide by 5.5 in. (~14.0 cm) top opening. BASKETS are secured to a metal extrusion using zip ties, and the entire metal extrusion attaches to the FIELD perimeter wall and is secured to the wall with thumb screws.

There are two BASKETS per ALLIANCE: a LOW BASKET and a HIGH BASKET. The lowest lip of the LOW BASKET is 25.75 in. (~65.4 cm) from the FIELD floor. The lowest lip of the HIGH BASKET is 43.0 in. (109.2 cm) from the FIELD floor.

Figure 9-10: BASKETS

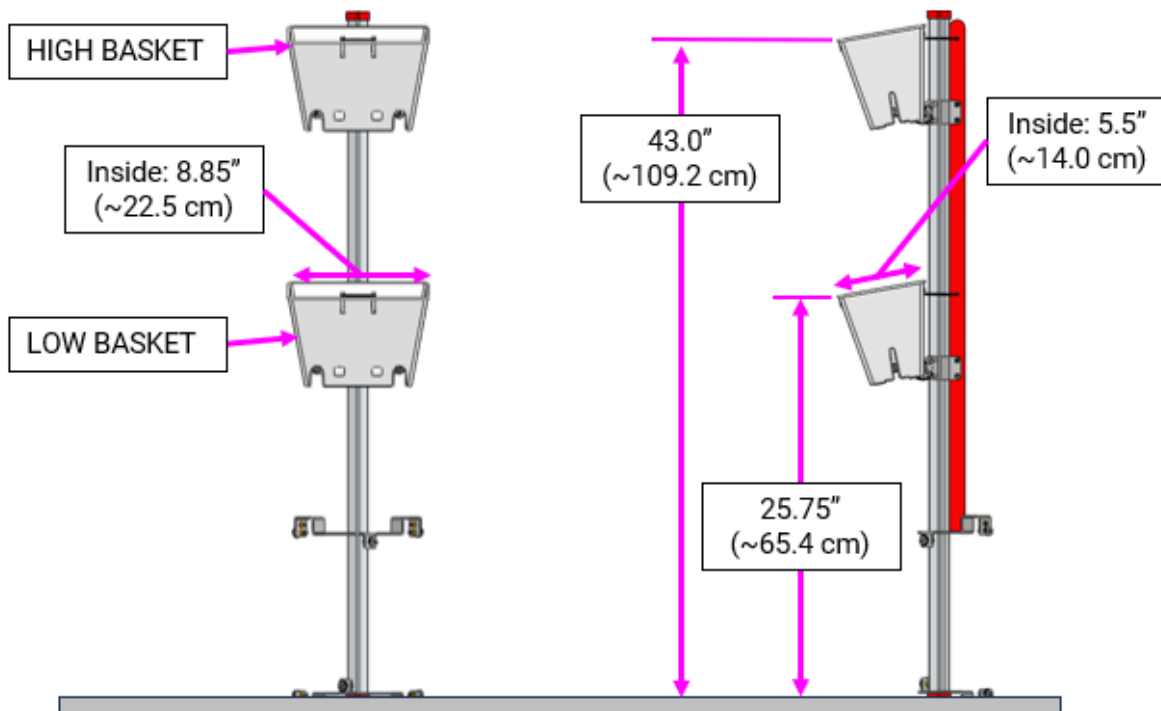
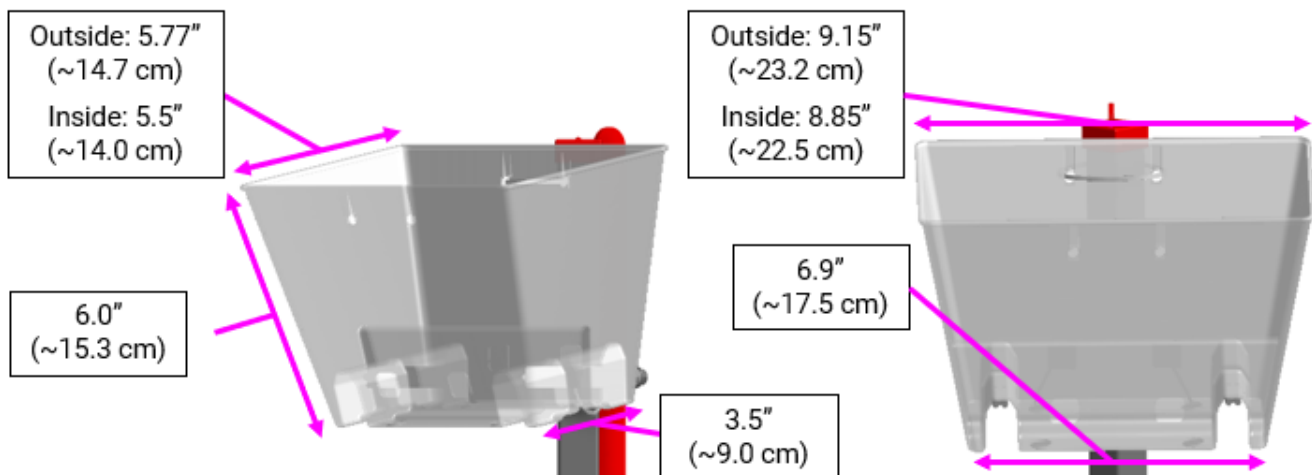

Figure 9-11: BASKET Dimensions



9.7 SCORING ELEMENTS

There are two different physical elements used in INTO THE DEEP: the SAMPLE and the CLIP. Red or blue ALLIANCE SPECIFIC SAMPLES can be combined with a CLIP to create a SPECIMEN. The SAMPLE and the SPECIMEN can be used to score points.

9.7.1 SAMPLES

A SAMPLE is a 3.5 in. (8.9 cm) long by 1.5 in. (3.8 cm) wide by 1.5 in. (3.8 cm) high rectangular prism shaped SCORING ELEMENT. There are forty (40) yellow SAMPLES, twenty (20) red SAMPLES, and twenty (20) blue SAMPLES. An ALLIANCE SPECIFIC SAMPLE with a CLIP attached is no longer a SAMPLE and is now a SPECIMEN. A neutral SAMPLE with a CLIP attached is still considered a SAMPLE.

Figure 9-12: SAMPLE

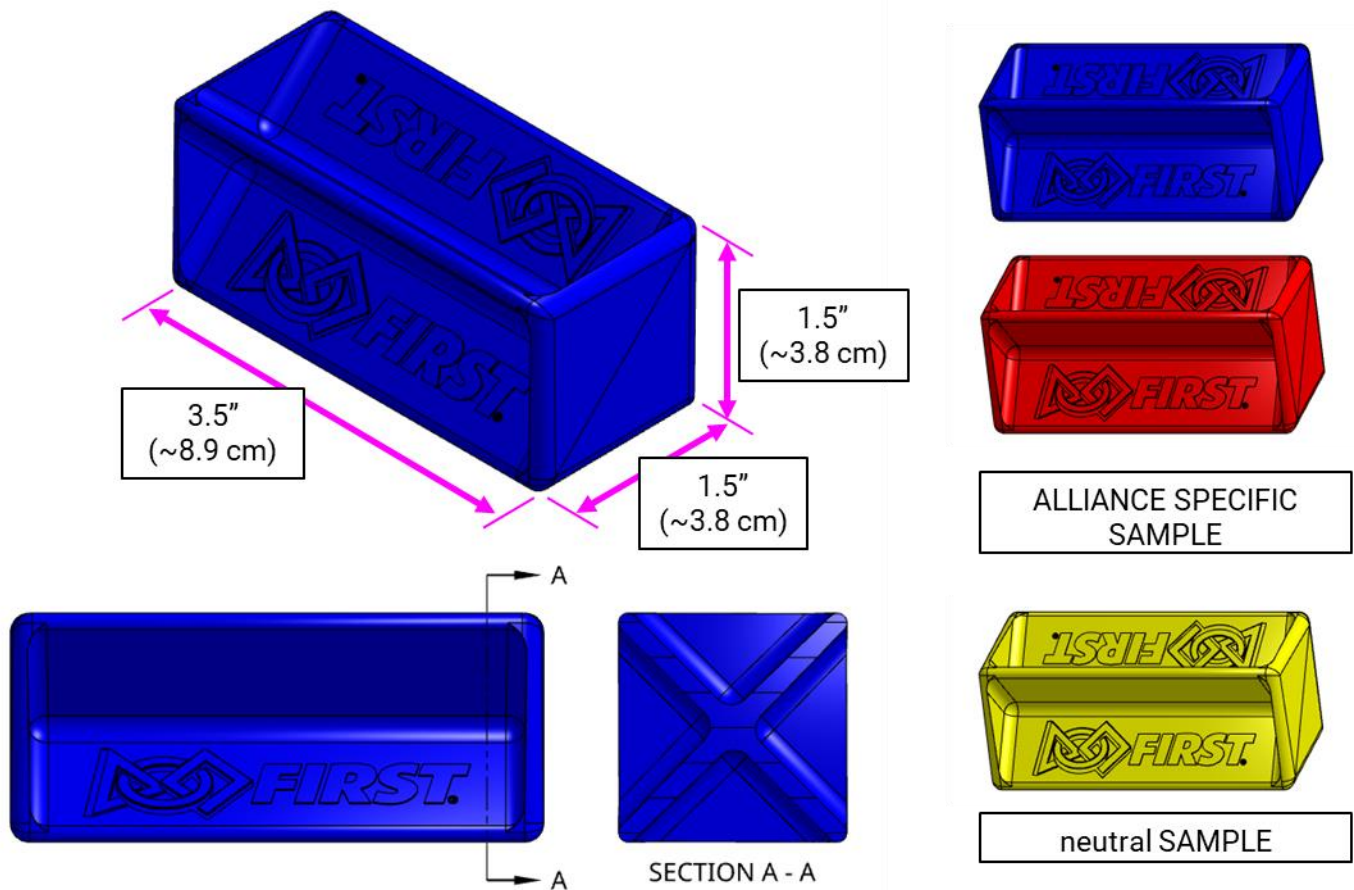

9.7.2 CLIP

The CLIP is a black plastic SCORING ELEMENT which is designed to be connected to an ALLIANCE SPECIFIC SAMPLE by a HUMAN PLAYER or ROBOT to create a SPECIMEN. The CLIP is a 2.5 in. (~6.4 cm) high by ~3.2 in. (~8.1 cm) long by 1 in. (~2.5 cm) wide.

Figure 9-13: CLIP Dimensions

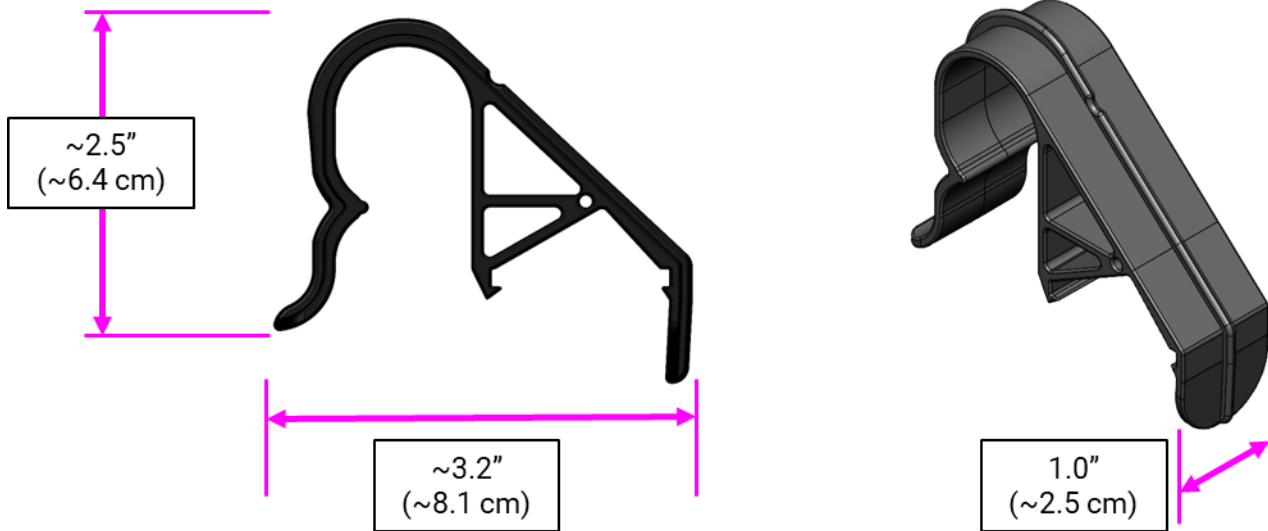

9.7.3 SPECIMEN

A SPECIMEN is a SCORING ELEMENT that is made up of one ALLIANCE SPECIFIC SAMPLE and at least one CLIP. The CLIP can be connected to the SAMPLE on the long or short side to create a SPECIMEN as shown in Figure 9-14.

Figure 9-14: Creating a SPECIMEN using an ALLIANCE SPECIFIC SAMPLE and a CLIP

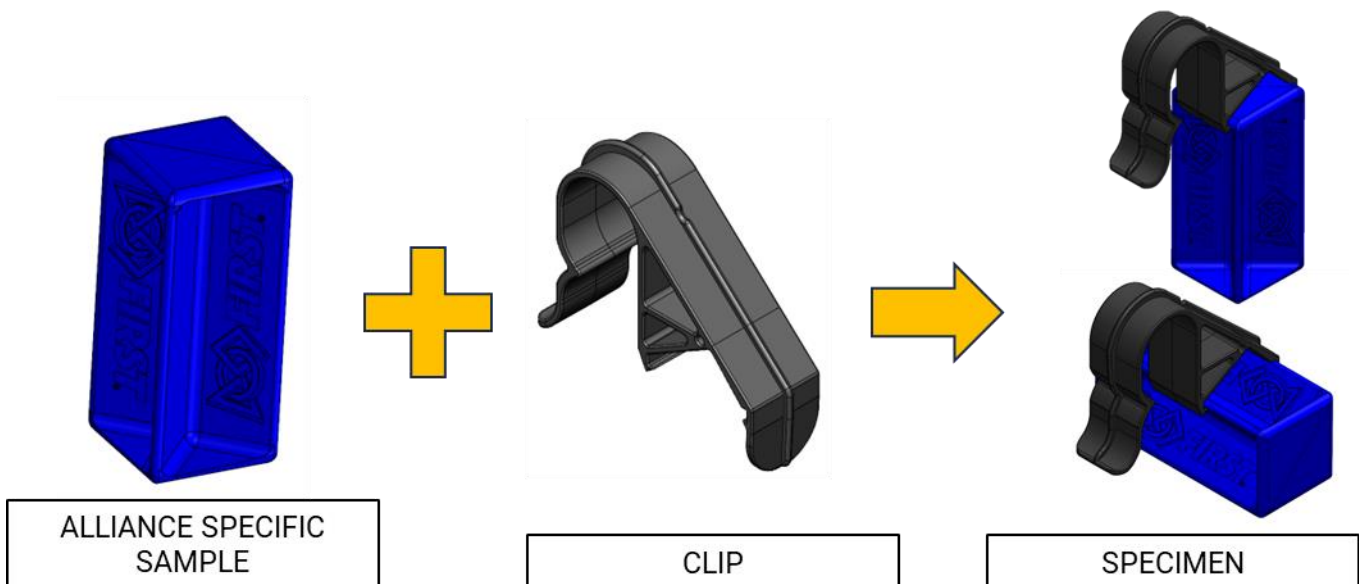

HUMAN PLAYERS may stage the SPECIMENS in any orientation in the OBSERVATION ZONE. This include hanging them from the adjacent FIELD wall or placing them on the TILES as shown in Figure 9-15.

Figure 9-15: SPECIMENS staged in the OBSERVATION ZONE

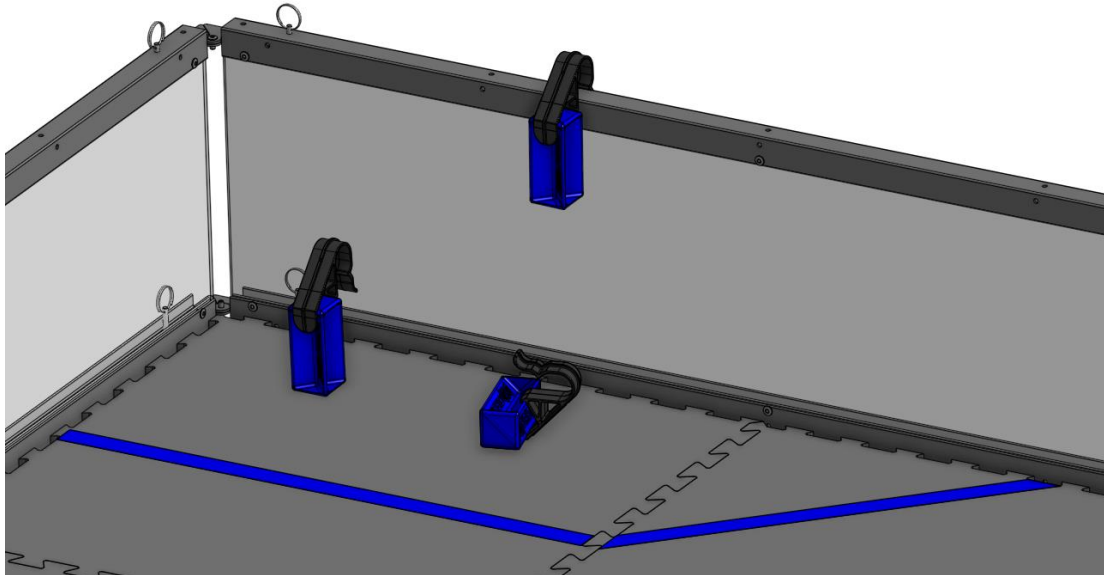

9.8 AprilTags

AprilTags are placed outside of the FIELD perimeter walls facing inward to help aid in ROBOT navigation. AprilTags for INTO THE DEEP are six 4 in. (~10.16 cm) square targets from the 36h11 tag family, IDs 11-16. Each marker has an identifying “TAG ID” text label.

Figure 9-16: AprilTag Locations

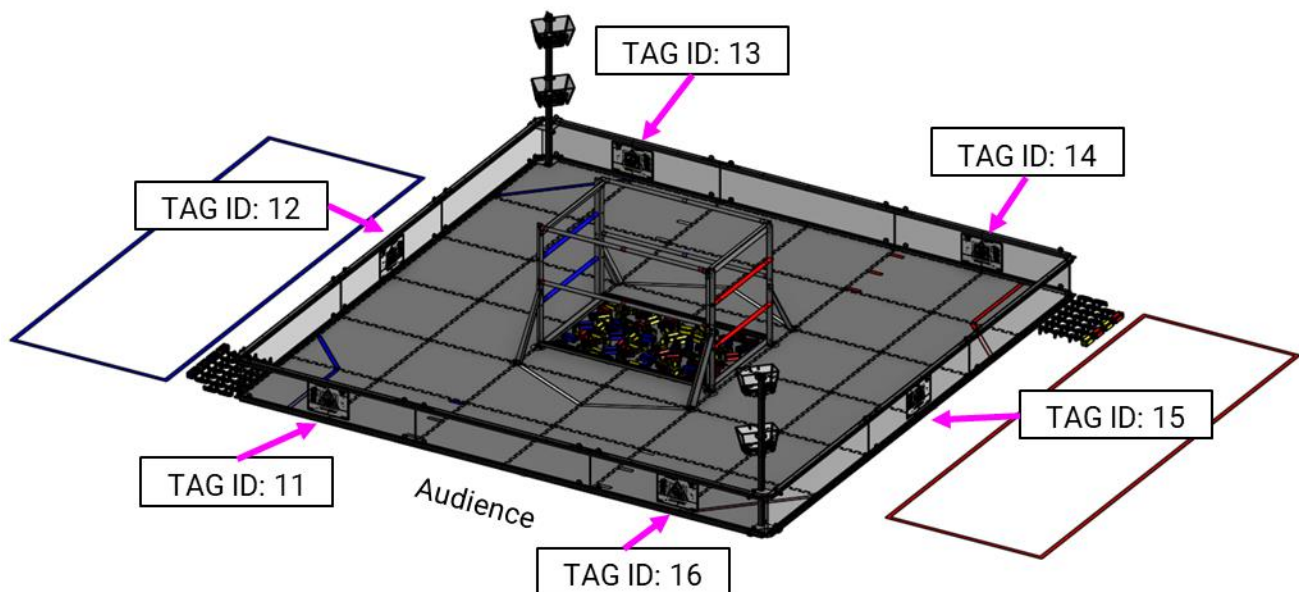
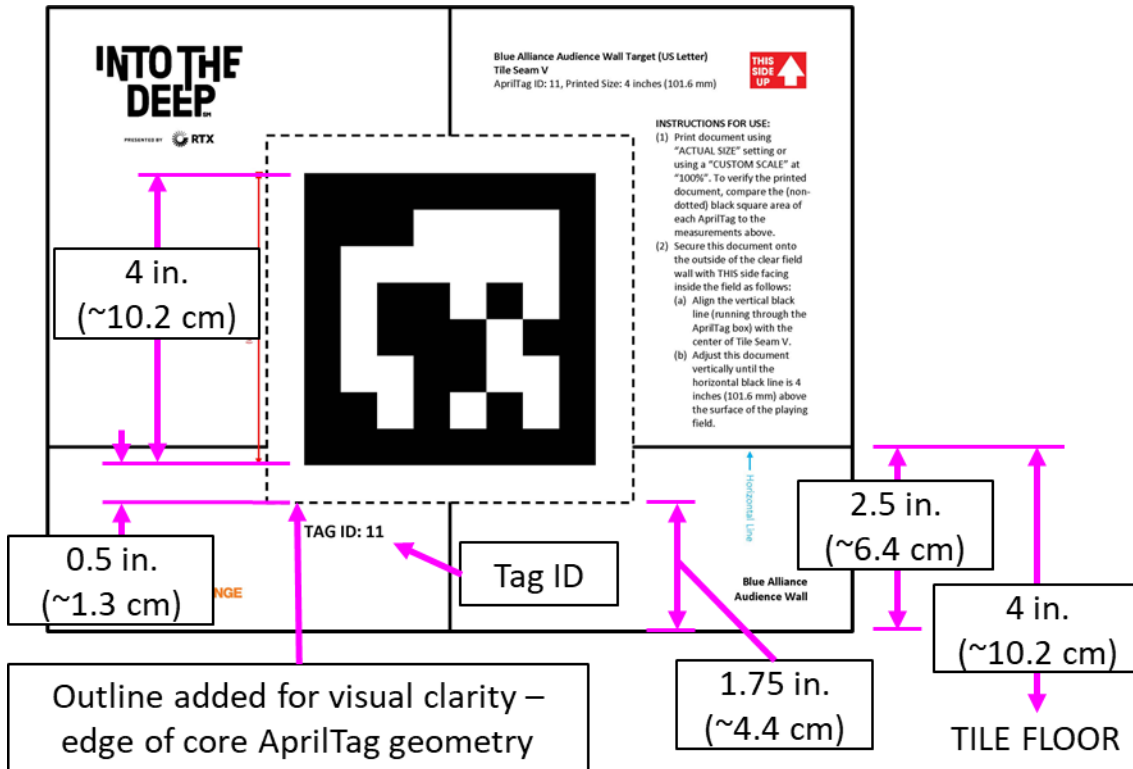

Figure 9-17: AprilTag sizing (placed in plastic sheet protectors)



Do not print the images from this manual for practice purposes, they are examples only and are not the same size as those used in the ARENA. Please refer to the [FIRST Tech Challenge Game and Season page](#) for printable versions of these images, including instructions on how to place the images correctly around the FIELD.

9.9 FIELD STAFF

FIELD STAFF are volunteers present in and around the ARENA that are responsible for making sure the MATCHES are cycled through efficiently, fairly, safely, and with a spirit of cooperation, *Gracious Professionalism*[®], and generosity of spirit. FIELD STAFF roles are filled by volunteers from the community who prepare for the event with thorough training and certification. There are 3 FIELD-side key volunteer roles with whom teams should be familiar with and are encouraged to use as resources to make their event experience valuable.

- Head REFEREE – trains, directs, and supervises REFEREES. They oversee all scoring processes and procedures in collaboration with other FIELD STAFF. They interact with STUDENTS, volunteers, and event staff. The Head REFEREE has final authority for decisions regarding MATCH scores, FOULS, and YELLOW and RED CARD assignments.
- FIRST technical advisor (FTA) - ensures events run smoothly, safely, and in accordance with FIRST requirements. The FTA collaborates with FIRST staff, event staff, and other event volunteers in many

different areas at events. The FTA focuses on all technical things related to the FIELD, ROBOTS, and game, and acts as a team advocate for all teams competing at the event.

- FIELD Supervisor - (may be the same as the FTA or Head REFEREE at smaller events) directs activity on the FIELD to ensure efficient execution of the MATCHES, pacing of the event, and smooth flow of MATCH play. FIELD Supervisors are responsible for ensuring the FIELD is intact and lead FIELD reset teams, who are responsible for resetting the FIELD after each MATCH in preparation for the subsequent MATCH.

For additional details about each of these roles, as well as other *FIRST* Tech Challenge volunteer roles, please refer to our [volunteer role descriptions](#).

9.10 Event Management System

The *FIRST* event management system is the software responsible for managing the MATCH scores and other event inputs. The system encompasses all FIELD electronics, including computers, displays, REFEREE and other volunteer electronic devices, the wireless access point, ethernet cables, etc.

The *FIRST* event management system alerts participants to milestones in the MATCH using audio cues detailed in Table 9-1. Please note that audio cues are intended as a courtesy to participants and not intended as official MATCH markers. If there is a discrepancy between an audio cue and the visual FIELD timers, the visual FIELD timers are the authority.

Table 9-1 Audio cues

Event	Timer Value	Audio Cue
MATCH start	2:30	“Cavalry Charge”
AUTO ends	2:00	“Buzzer x 3”
AUTO to TELEOP Transition	0:07 → 0:01	“Drivers, pick up your controllers, 3-2-1”
TELEOP begins	2:00	“3 Bells”
Final 30 seconds	0:30	“Train Whistle”
MATCH end	0:00	“3-second Buzzer”
MATCH stopped	N/A	“Foghorn”



10 Game Details

Figure 10-1: FIELD for INTO THE DEEP presented by RTX

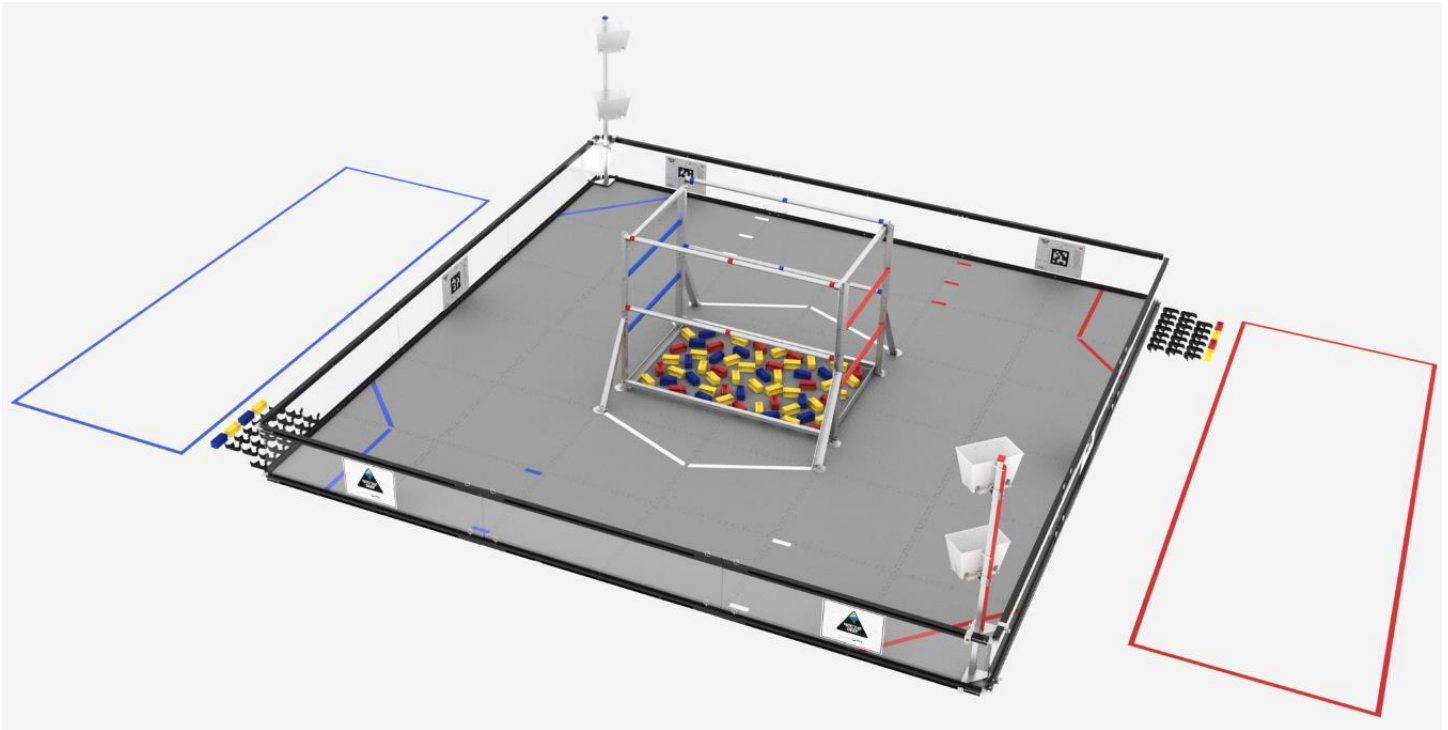

In INTO THE DEEP, 2 ALLIANCES (an ALLIANCE is a cooperative of 2 FIRST Tech Challenge teams) play MATCHES, set up and implemented per the details described below.

10.1 MATCH Overview

MATCHES run on a typical 6-10-minute cycle time per FIELD, which consists of pre-MATCH setup, a 30 second AUTO period, an 8 second transition period between AUTO and TELEOP, and a 2-minute TELEOP period, followed by the post-MATCH reset.

During the MATCH, ROBOTS score SAMPLES into BASKETS and SPECIMENS on the CHAMBERS. ALLIANCE-colored SAMPLES can be turned into SPECIMENS by returning them to the OBSERVATION ZONE where the HUMAN PLAYER can add a CLIP.

ROBOTS conclude the MATCH by either PARKING in their OBSERVATION ZONE or ASCENDING the RUNGS of the SUBMERSIBLE.

10.2 DRIVE TEAM

A DRIVE TEAM is a set of up to 4 people from the same FIRST Tech Challenge team responsible for team performance for a specific MATCH. There are 3 specific roles on a DRIVE TEAM which ALLIANCES can use to assist ROBOTS, and no more than 1 member of the DRIVE TEAM is allowed to be a non-STUDENT.

The intent of the definition of DRIVE TEAM and DRIVE TEAM related rules is that, barring extenuating circumstances, the DRIVE TEAM consists of people who arrived at the event affiliated with that team and are responsible for their team’s and ROBOT’S performance at the event (this means a person may be affiliated with more than 1 team). The intent is not to allow teams to “adopt” members of other teams for strategic advantage for the loaning team, borrowing team, and/or their ALLIANCE (e.g., an ALLIANCE CAPTAIN believes 1 of their DRIVERS has more experience than a DRIVER of their ALLIANCE partner, and the teams agree the first pick team will “adopt” that DRIVER and make them a member of their DRIVE TEAM for playoffs).

The definition is not stricter for two main reasons. First, to avoid additional bureaucratic burden on teams and event volunteers (e.g., requiring that teams submit official rosters that Queuing must check before allowing a DRIVE TEAM into the ARENA). Second, to provide space for exceptional circumstances that give teams the opportunity to display *Gracious Professionalism* (e.g., a bus is delayed, a DRIVE COACH has no DRIVERS, and their pit neighbors agree to help by loaning DRIVERS as temporary members of the team until their bus arrives).

Table 10-1: DRIVE TEAM roles

Role	Description	Max./ DRIVE TEAM	Criteria
DRIVE COACH	a guide or advisor	1	any team member and may be an adult, must wear “DRIVE COACH” badge
DRIVER	an operator and controller of the ROBOT	2	STUDENT, must wear a “DRIVER” badge
HUMAN PLAYER	a SCORING ELEMENT manager	1*	STUDENT, must wear a “HUMAN PLAYER” badge

*Only one HUMAN PLAYER will represent an ALLIANCE in a MATCH. If an ALLIANCE cannot agree on which team's HUMAN PLAYER will participate in a MATCH, The HUMAN PLAYER from the team listed as "Red 1" or "Blue 1" in the MATCH schedule will be used

A STUDENT is a person who has not completed high-school, secondary school, or the comparable level in their home region as of September 1st of the current season.

10.3 Setup

Before each MATCH begins, FIELD STAFF stage SCORING ELEMENTS as described in section [10.3.1 SCORING ELEMENTS](#). DRIVE TEAMS stage their ROBOTS (as described in section [10.3.4 ROBOTS](#)) and OPERATOR CONSOLES (as described in section [10.3.3 OPERATOR CONSOLES](#)). Then, DRIVE TEAMS take their places as described in section [10.3.2 DRIVE TEAMS](#).

10.3.1 SCORING ELEMENTS

Before each MATCH begins, FIELD STAFF stage SCORING ELEMENTS according to Figure 10-2.

Figure 10-2: SCORING ELEMENTS staging positions

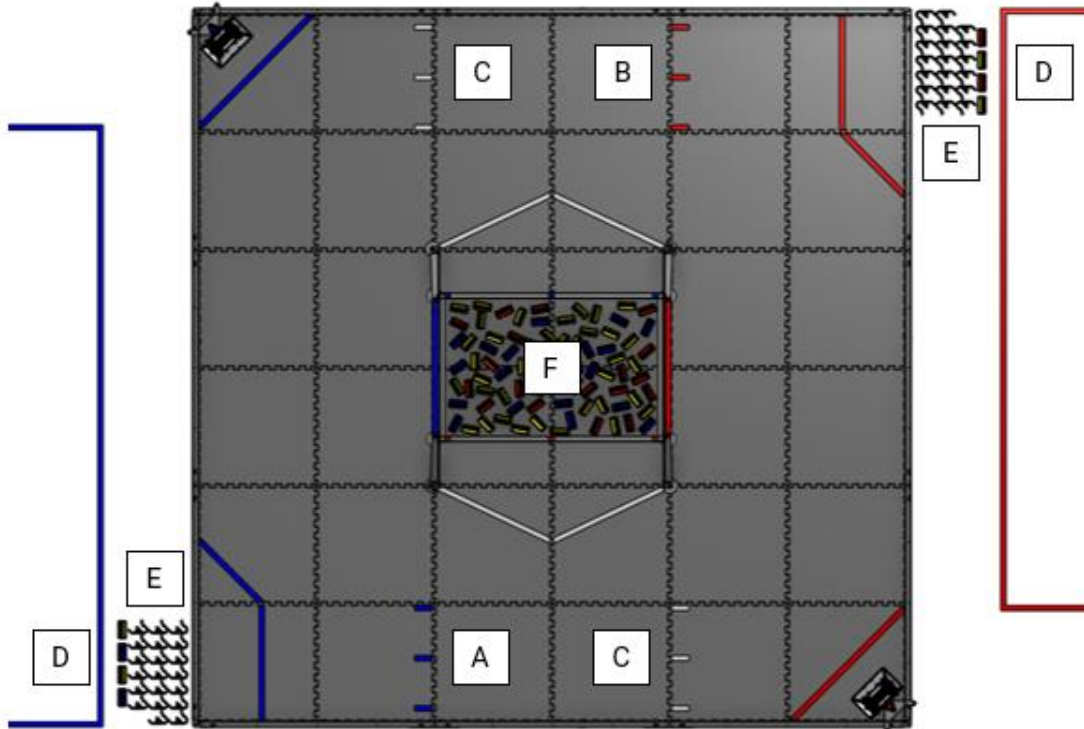

80 SAMPLES (20 red, 20 blue, and 40 neutral) and 40 CLIPS that are staged as follows:

- A. Blue ALLIANCE SAMPLES – 3 blue SAMPLES are placed on each of the 3 SPIKE MARKS on TILE B1
- B. Red ALLIANCE SAMPLES – 3 red SAMPLES are placed on each of the 3 SPIKE MARKS on TILE E6
- C. Neutral SAMPLES – 3 neutral SAMPLES are placed on each of the 3 SPIKE MARKS on TILES B6 and E1
- D. 2 neutral SAMPLES and 2 corresponding ALLIANCE SPECIFIC SAMPLES are placed on the floor outside the FIELD wall between the ALLIANCE AREA and the wall
- E. 20 CLIPS are placed on the floor outside the FIELD wall between the ALLIANCE AREA and the wall
- F. SAMPLES inside the SUBMERSIBLE ZONE – 15 red SAMPLES, 15 blue SAMPLES, and 30 neutral SAMPLES are randomly placed inside the SUBMERSIBLE

From the SCORING ELEMENTS provided in D and E each ROBOT may be pre-loaded with either 1 SAMPLE or one SPECIMEN such that it is in contact with the ROBOT and not in the OBSERVATION ZONE or NET ZONE. SAMPLES or CLIPS not pre-loaded will remain in setup locations D and E.

All of the SPIKE MARK locations are measured relative to the inner tooth TILE edge towards the center of the FIELD as shown in Figure 10-3.

SAMPLES should be placed on SPIKE MARKS such that they are completely covering the SPIKE MARK. Teams may adjust the placement of SAMPLES on the SPIKE MARKS in front of their DRIVE TEAM as long as the SAMPLE completely covers the SPIKE MARK and there is no delay to the start of the MATCH.

Where there is variance in the relative sizing of the SAMPLES and the SPIKE MARK, a best effort should be made to completely cover the SPIKE MARK.

Figure 10-3: SPIKE MARK Locations on TILE B1

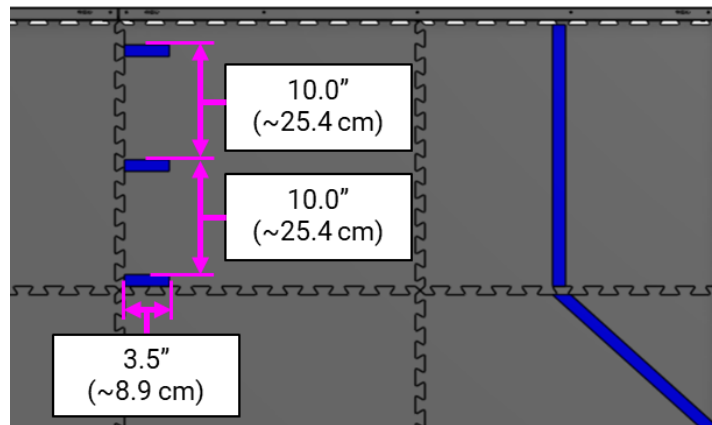

10.3.2 DRIVE TEAMS

DRIVE TEAMS prepare for a MATCH by staging in the ALLIANCE AREA after the DRIVE TEAM from the previous MATCH has left. DRIVE TEAM starting conditions are listed below, and a DRIVE TEAM obstructing or delaying any of the conditions is at risk of violating [G301](#).

- A. only DRIVE TEAM members assigned to the upcoming MATCH are present.
- B. only DRIVE TEAM members whose ROBOTS have passed initial, complete Inspection are present.
- C. one HUMAN PLAYER per ALLIANCE has been identified and is standing in their designated ALLIANCE AREA.
- D. DRIVERS are standing in their designated ALLIANCE AREA. If members of the ALLIANCE cannot agree where their DRIVERS and COACH will stand, the team listed on the MATCH schedule as “Red 1” or “Blue 1” will stand in the station closest to the audience.
- E. DRIVE TEAM members clearly display their designated badges above their waists.

10.3.3 OPERATOR CONSOLES

DRIVE TEAMS set up their OPERATOR CONSOLES as soon as they are staged in their ALLIANCE AREA. OPERATOR CONSOLES must be compliant with all relevant rules, specifically those in section [12.9 OPERATOR CONSOLE](#). A DRIVE TEAM obstructing or delaying OPERATOR CONSOLE set up is at risk of violating [G301](#).

- A. DRIVE TEAMS running an AUTO OpMode during the AUTO period must select an OpMode within their DRIVER STATION app with the 30 second timer enabled.
- B. DRIVE TEAMS not running an OpMode during the AUTO period must select a TELEOP OpMode within the DRIVER STATION app.
- C. the OpMode must be initialized by pressing the “INIT” button on the DRIVER STATION app.

10.3.4 ROBOTS

DRIVE TEAMS stage their ROBOT in accordance with [G303](#). A DRIVE TEAM obstructing or delaying ROBOT setup requirements is at risk of violating [G301](#).

If order of placement matters to either or both ALLIANCES, the ALLIANCE notifies the Head REFEREE or their designee before set up for that MATCH, and the Head REFEREE instructs ALLIANCES to alternate placement of ROBOTS. REFEREE instructions are that ROBOTS are placed in the following order:

1. first red ROBOT
2. first blue ROBOT
3. second red ROBOT
4. second blue ROBOT

In qualification MATCHES the ROBOT assigned to Red 1 or Blue 1 places first within their ALLIANCE. In playoff MATCHES the ALLIANCE CAPTAIN decides which ROBOT places first within their ALLIANCE.

10.4 MATCH Periods

The first period of each MATCH is 30 seconds long and called the autonomous period (AUTO). During AUTO, ROBOTS operate without any DRIVER control or input. ROBOTS attempt to score SAMPLES, PARK in the OBSERVATION ZONE, contact the SUBMERSIBLE, hang SPECIMENS onto a CHAMBER, and retrieve additional SAMPLES. There is an 8-second delay between AUTO and TELEOP for scoring purposes as described in Section [10.5 Scoring](#).

The second period of each MATCH is 2 minutes (2:00) and called the teleoperated period (TELEOP). During TELEOP, DRIVERS remotely operate ROBOTS to retrieve and score SAMPLES, hang SPECIMENS onto the CHAMBER, and PARK in the OBSERVATION ZONE or ASCEND the RUNGS to achieve points.

10.5 Scoring

ALLIANCES are rewarded for their performance during MATCHES via MATCH points and RANKING POINTS (RP), which increase the measure used to rank teams per section [13.5.3 Qualification Ranking](#).

ALLIANCES are rewarded MATCH points for accomplishing tasks through the course of a MATCH, including:

- PARKING in the OBSERVATION ZONE
- scoring SAMPLES in the NET ZONE and BASKETS
- scoring SPECIMENS on their CHAMBERS, and
- ASCENDING their RUNGS

All accomplishments are tracked live by FIELD STAFF and certified at the end of the MATCH.

Accomplishments are officially scored at the end of each MATCH period based on the status of the FIELD, when all ROBOTS and SCORING ELEMENTS have come to rest, except as follows:

- A. assessment of ASCENT and PARKING points is made 3 seconds after the ARENA timer reaches the end of the MATCH period following AUTO and TELEOP, or when all ROBOTS have come to rest following the conclusion of the MATCH period, whichever happens first.
- B. scoring achievements that occur after the end of the AUTO period and before the start of the TELEOP period will count in the TELEOP period but may violate [G403](#).

ALLIANCES are rewarded RANKING POINTS (RP) for winning or tying MATCHES, which is determined by MATCH points earned by each ALLIANCE.

10.5.1 SAMPLE Scoring Criteria

A SAMPLE is scored in the NET ZONE when it is fully or partially inside the NET ZONE.

A SAMPLE is scored into the BASKET when fully or partially contained within the volume of the inside surface of the BASKET or fully supported by the BASKET either directly or transitively through other SAMPLES.

SAMPLES that are scored in either the LOW or HIGH BASKET only count as scored in a BASKET and not in the NET ZONE.

SAMPLES scored into a NET or BASKET count for the ALLIANCE that owns that NET or BASKET.

A neutral SAMPLE with a CLIP attached in the NET ZONE or either the LOW or HIGH BASKETS have no score value.

A SAMPLE of any color will score in any BASKET or NET ZONE, but beware of violating [G407](#) and [G411](#).

Figure 10-4: Example NET ZONE scoring

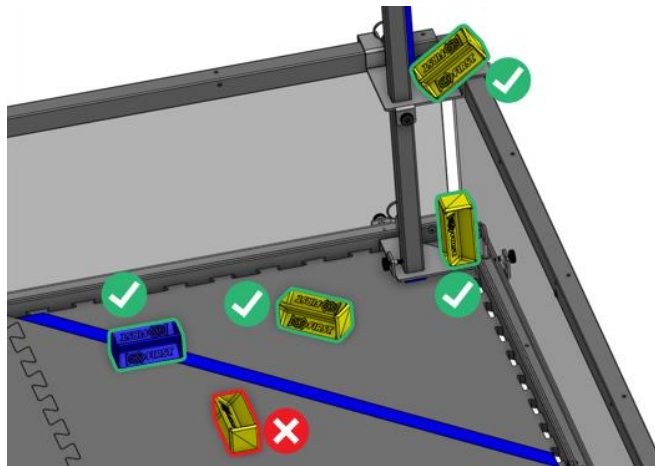

10.5.2 SPECIMEN Scoring Criteria

A SPECIMEN is considered scored if the SPECIMEN is fully supported by a corresponding ALLIANCE SPECIFIC CHAMBER (Figure 10-5) either directly or transitively through other SPECIMENS.

SPECIMENS in the NET ZONE or either the LOW or HIGH BASKETS have no score value.

For example, the SPECIMEN composed of a red ALLIANCE SPECIFIC SAMPLE and a CLIP will only score on the red CHAMBERS.

Figure 10-5: SPECIMEN scored on a CHAMBER

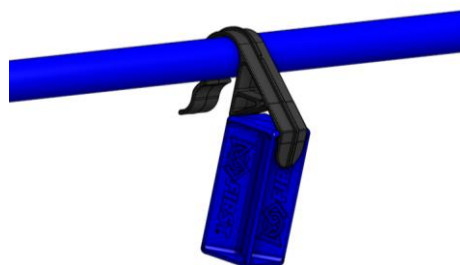

10.5.3 ROBOT Scoring Criteria

A ROBOT receives PARKING points when the ROBOT is fully or partially inside the OBSERVATION ZONE at the end of a MATCH period.

ASCENT points are assigned as follows:

Table 10-2: ASCENT LEVEL Criteria

ASCENT	Definition
LEVEL 1	ROBOT is in contact with the LOW RUNG at the end of a MATCH period (per section 10.5 Scoring item A)
LEVEL 2	ROBOT is fully supported by the HIGH and/or LOW RUNGS at the end of the MATCH (per section 10.5 Scoring item A)
LEVEL 3	ROBOT is fully supported by the HIGH RUNG and completely above the top of the LOW RUNG at the end of the MATCH (per section 10.5 Scoring item A)

Lateral contact with non-RUNG elements of the SUBMERSIBLE is allowed for stabilization of the ROBOT while ASCENDING.

The intent of the use of “fully support” language is that the ROBOTS are solely supported by the RUNGS when the ASCENT is scored. ROBOTS which make incidental contact (e.g. not used for ROBOT support or stabilization) to the non-RUNG SUBMERSIBLE structural elements or ALLIANCE partner ROBOT as judged by the REFEREES, at the conclusion of their ASCENT are still eligible for ASCENT points.

Additionally, the following conditions must be met:

- A. ROBOTS can only ASCEND their own ALLIANCE SPECIFIC RUNGS.
- B. ROBOTS must start their ASCENT with their CHASSIS completely outside the SUBMERSIBLE ZONE.
- C. for a LEVEL 3 ASCENT, ROBOTS may not contact the HIGH RUNG while:
 - i. supported by the TILES directly or transitively through another object (e.g., SCORING ELEMENTS or another ROBOT), or
 - ii. grasping any other part of the SUBMERSIBLE structure except for the LOW RUNG
- D. ROBOTS that are eligible for multiple ASCENTS or ASCENT and PARKING points only earn points for the highest value achievement.

If any of the above conditions are not met, it is not a valid ASCENT. If a ROBOT does not meet ASCENT criteria, the ROBOT may disengage from the SUBMERSIBLE and attempt the ASCENT again.

A ROBOT is considered ASCENDING once it is attempting to achieve an ASCENT LEVEL, and ASCENDED once it has achieved an ASCENT LEVEL.

The intent of part B of this rule is for the ROBOT to start its ASCENT outside of the SUBMERSIBLE ZONE except for elements used by the ROBOT to contact the

RUNG. Once ROBOTS start their ASCENT, parts of the CHASSIS may swing into the SUBMERSIBLE ZONE, which is not a violation of this rule.

ROBOTS attempting a LEVEL 3 ASCENT which then violate C. i or ii, may still be eligible for lower LEVEL ASCENT points as long as all other lower LEVEL ASCENT criteria are met at the end of the MATCH period. In this scenario, if a ROBOT would like to reattempt a LEVEL 3 ASCENT they must disengage from the SUBMERSIBLE and attempt their LEVEL 3 ASCENT again.

ROBOTS supported by an ALLIANCE partner ROBOT, SCORING ELEMENTS, other non-RUNG elements of the SUBMERSIBLE or the FIELD floor will not be awarded an ASCENT LEVEL 2 or 3.

10.5.4 Point Values

Table 10-3: INTO THE DEEP point values

		MATCH points		RANKING POINTS
		AUTO	TELEOP	
PARK	OBSERVATION ZONE	3	3	
	NET ZONE	2	2	
SAMPLE	LOW BASKET	4	4	
	HIGH BASKET	8	8	
SPECIMEN	LOW CHAMBER	6	6	
	HIGH CHAMBER	10	10	
ASCENT	LEVEL 1	3	3	
	LEVEL 2		15	
	LEVEL 3		30	
Tie	completing a MATCH with the same number of MATCH points as your opponent			
Win	completing a MATCH with more MATCH points than your opponent			2

10.6 Violations

FIRST Tech Challenge uses 3 words in the context of how durations and actions are assessed with regards to evaluation of rules and assignment of violations. These words provide general guidance to describe benchmarks. It is not the intent for REFEREES to provide a count during the time periods.

- MOMENTARY describes durations that are fewer than approximately 3 seconds.
- CONTINUOUS describes durations that are more than approximately 10 seconds.
- REPEATED describes actions that happen more than once within a MATCH.

For each instance of a rule violation, unless otherwise noted, 1 or more of the penalties listed in Table 10-4 are assessed.

Table 10-4 Rule violations

Penalty	Description
MINOR FOUL	a credit of 5 points towards the opponent's MATCH point total
MAJOR FOUL	a credit of 15 points towards the opponent's MATCH point total
YELLOW CARD	a warning issued by the Head REFEREE for egregious ROBOT or team member behavior or rule violations. A subsequent YELLOW CARD within the same tournament phase results in a RED CARD.
RED CARD	a penalty issued by the Head REFEREE for egregious ROBOT or team member behavior or rule violations which results in a team being DISQUALIFIED for the MATCH.
DISABLED	The REFEREE instructs the team to stop the ROBOT which will deactivate all outputs, rendering the ROBOT inoperable for the remainder of the MATCH.
DISQUALIFIED	the state of a team in which they receive 0 MATCH points and 0 RANKING POINTS in a qualification MATCH or causes their ALLIANCE to receive 0 MATCH points in a playoff MATCH

10.6.1 YELLOW and RED CARDS

In addition to rule violations explicitly listed throughout this document, YELLOW CARDS and RED CARDS are used in FIRST Tech Challenge to address team and ROBOT behavior that does not align with the mission, values, and culture of FIRST.

The Head REFEREE may assign a YELLOW CARD as a warning, or a RED CARD for egregious behavior inappropriate at a FIRST Tech Challenge event. A team that has received either a YELLOW or a RED CARD carries a YELLOW CARD into subsequent MATCHES, except as noted below. A RED CARD results in MATCH DISQUALIFICATION.

A YELLOW or RED CARD is indicated by the Head REFEREE holding a YELLOW and/or RED CARD in the air while a member of the FIELD STAFF describes the violation to the audience.

YELLOW CARDS are additive, meaning that a second YELLOW CARD is automatically converted to a RED CARD. A team is issued a RED CARD for any subsequent incident in which they receive an additional YELLOW CARD, including earning a second YELLOW CARD during a single MATCH. A second YELLOW CARD is indicated by the Head REFEREE holding a YELLOW CARD and RED CARD in the air simultaneously after the

completion of the MATCH. A team that has received either a YELLOW CARD or a RED CARD carries a YELLOW CARD into subsequent MATCHES, except as noted below.

Once a team receives a YELLOW or RED CARD, its team number is presented with a yellow background on the audience screen during all subsequent MATCHES, including any replays, as a reminder to the team, the REFEREES, and the audience that they carry a YELLOW CARD.

Egregious behavior by a team, which cannot be resolved locally by the Head REFEREE or Event Director working directly with the STUDENT and adult team members, will be escalated to FIRST Headquarters. In consultation with FIRST Headquarters the team may be DISQUALIFIED from all subsequent MATCHES and removed from awards consideration.

Figure 10-6 Example audience screen graphic showing YELLOW CARD indicators



All YELLOW CARDS are cleared at the conclusion of qualification MATCHES, and division playoff MATCHES. Verbal warnings persist from qualification MATCHES through subsequent tournament phases, except when stated otherwise.

10.6.2 YELLOW and RED CARD application

YELLOW and RED CARDS are applied based on the following:

Table 10-5 YELLOW and RED CARD application

Time YELLOW or RED CARDS earned:	MATCH to which CARD is applied:
before the start of qualification MATCHES	team's first qualification MATCH
during the qualification MATCHES	team's current (or just completed) MATCH in which they are not a SURROGATE. For SURROGATE MATCHES the card is applied to the team's previous qualification MATCH.
between the end of qualification MATCHES and the start of playoff MATCHES	ALLIANCE'S first playoff MATCH
during the playoff MATCHES	ALLIANCE'S current (or just completed) MATCH

A MATCH is no longer the current MATCH once the score has been posted or the Head REFEREE or their designee has indicated that teams can collect their ROBOTS, whichever is later.

Please see examples of the application of YELLOW and RED CARDS as shown in section [10.6.4 Violation Details](#).

10.6.3 YELLOW and RED CARDS during playoff MATCHES

During playoff MATCHES, YELLOW and RED CARDS are assigned to the violating team’s entire ALLIANCE instead of to only the violating team. If an ALLIANCE receives 2 YELLOW CARDS, the entire ALLIANCE is issued a RED CARD which results in DISQUALIFICATION for the associated MATCH.

10.6.4 Violation Details

There are several styles of violation wording used in this manual. Below are some example violations and a clarification of the way the violation would be assessed. The examples shown do not represent all possible violations, but rather a representative set of combinations.

Table 10-6 Violation examples

EXAMPLE VIOLATION	EXPANDED INTERPRETATION
MINOR FOUL	Upon violation, a MINOR FOUL is assessed against the violating ALLIANCE.
MAJOR FOUL AND YELLOW CARD	Upon violation, a MAJOR FOUL is assessed against the violating ALLIANCE. After the MATCH, the Head REFEREE presents the violating team with a YELLOW CARD.
MINOR FOUL PER ADDITIONAL SCORING ELEMENT. IF EGREGIOUS, YELLOW CARD	Upon violation, a number of MINOR FOULS are assessed against the violating ALLIANCE equal to the number of additional SCORING ELEMENTS beyond the permitted quantity. Additionally, if the REFEREES determine that the action was egregious, the Head REFEREE presents the violating team with a YELLOW CARD after the MATCH.
MAJOR FOUL, PLUS AN ADDITIONAL MAJOR FOUL FOR EVERY 5 SECONDS IN WHICH THE SITUATION IS NOT CORRECTED	Upon violation, a MAJOR FOUL is assessed against the violating ALLIANCE and the REFEREE begins to count. Their count continues until the criteria to discontinue the count are met, and for each 5 seconds within that time, an additional MAJOR FOUL is assessed against the violating ALLIANCE. A ROBOT in violation of this type of rule for 15 seconds receives a total of 4 MAJOR FOULS (assuming no other rules were being simultaneously violated).
RED CARD FOR THE ALLIANCE	After the MATCH, the Head REFEREE presents the violating ALLIANCE with a RED CARD in the following fashion: In a playoff MATCH, a single RED CARD is assessed to the ALLIANCE. In all other scenarios, each team on the ALLIANCE is issued a RED CARD.

10.7 Head REFEREE

The Head REFEREE has the ultimate authority in the ARENA during the event, but may receive input from additional sources, e.g., FIRST personnel, FTA, Event Director, or other event staff. The Head REFEREE rulings are final. No event staff, including the head REFEREE, will review video, photos, artistic renderings, etc. of any MATCH, from any source, under any circumstances.

10.8 Other Logistics

SCORING ELEMENTS that leave the FIELD during a MATCH cannot be used in further gameplay during that MATCH and are not returned to gameplay by FIELD STAFF.

An ARENA FAULT (an error in ARENA operation described in section [13.3 MATCH Replays](#)) is not called for MATCHES that accidentally begin with damaged SCORING ELEMENTS, the incorrect number of SCORING ELEMENTS, or incorrectly placed SCORING ELEMENTS. Damaged SCORING ELEMENTS are not replaced until the next MATCH reset. DRIVE TEAMS should alert the FIELD STAFF to any missing, incorrectly placed, or damaged SCORING ELEMENTS prior to the start of the MATCH.

Once the MATCH is over and the Head REFEREE or their designee determines that the FIELD and FIELD STAFF are ready, they will signal for FIELD reset and DRIVE TEAMS may retrieve their ROBOT.

During MATCH reset, the FIELD is cleared of ROBOTS and OPERATOR CONSOLES from the MATCH that just ended, ROBOTS and OPERATOR CONSOLES for the subsequent MATCH are loaded into the FIELD by DRIVE TEAMS, and FIELD STAFF reset ARENA elements.



11 Game Rules (G)

11.1 Personal Safety

G101 ***Humans, stay off the FIELD during the MATCH.** Other than actions explicitly allowed in sections [SCORING ELEMENTS](#), [SCORING ELEMENTS](#) and [11.4.6 Human](#) a DRIVE TEAM member may only enter the FIELD during pre-MATCH set-up to place their ROBOT or after a MATCH is over to collect their ROBOT when instructed to do so by the Head REFEREE or their designee.

Violation: Verbal warning plus YELLOW CARD if subsequent violations occur during the event.

G102 ***Be careful when interacting with ARENA elements.** A team member is prohibited from the following actions with regards to interaction with ARENA elements:

- A. climbing on
- B. hanging from
- C. manipulating such that it does not return to its original shape without human intervention, and
- D. damaging

Violation: Verbal warning plus YELLOW CARD if subsequent violations occur during the event.

11.2 Conduct

G201 ***Be a good person.** All teams must be civil toward everyone and respectful of team and event equipment while at a FIRST Tech Challenge event. Please review the FIRST [Code of Conduct](#) and [Core Values](#) for more information.

Violation: Verbal warning plus YELLOW CARD if subsequent violations occur during the event. Further violations of this rule are addressed in rule [G211](#).

Examples of inappropriate behavior include, but are not limited to, the use of offensive language or other uncivil conduct.

Examples of particularly contemptible behavior that is likely to result in ARENA ejection include, but are not limited to, the following:

- A. assault, e.g., throwing something that hits another person (even if unintended),
- B. threat, e.g., saying something like “if you don’t reverse that call, I’ll make you regret it,”
- C. harassment, e.g., badgering someone with no new information after a decision has been made or a question has been answered,
- D. bullying, e.g., using body or verbal language to cause another person to feel inadequate,
- E. insulting, e.g., telling someone they don’t deserve to be on a DRIVE TEAM,
- F. swearing at another person (versus swearing under one’s breath or at oneself), and
- G. yelling at another person(s) in anger or frustration.

G202 *DRIVE TEAM Interactions. Opposing ALLIANCES' DRIVE TEAM members cannot distract/interfere with the opposing ALLIANCE. This includes taunting or other disruptive behavior.

Violation: Verbal warning plus YELLOW CARD if subsequent violations occur during the event.

G203 *Asking other teams to throw a MATCH – not cool. A team may not encourage an ALLIANCE of which it is not a member to play beneath its ability.

NOTE: This rule is not intended to prevent an ALLIANCE from planning and/or executing its own strategy in a specific MATCH in which all the teams are members of the ALLIANCE.

Violation: Verbal warning plus YELLOW CARD if subsequent violations occur during the event.

Example 1: A MATCH is being played by teams A and B, in which team B is encouraged by team D to not achieve a LEVEL 3 ASCENT, resulting in teams A and B losing the MATCH. Team D's motivation for this behavior is to prevent team A from rising in the tournament rankings and negatively affecting team D's ranking. Team D has violated this rule.

Example 2: A MATCH is being played by teams A and B, in which team A is assigned to participate as a SURROGATE. Team D encourages team A not to participate in the MATCH so that team D gains ranking position over team B. Team D has violated this rule.

Example 3: Asking a team to "no show" for a MATCH.

FIRST considers the action of a team influencing another team to throw a MATCH, to deliberately lower their tie breaker scores, etc. incompatible with FIRST values and not a strategy any team should employ.

G204 *Letting someone coerce you into throwing a MATCH – also not cool. A team, as the result of encouragement by a team not on their ALLIANCE, may not play beneath its ability.

NOTE: This rule is not intended to prevent an ALLIANCE from planning and/or executing its own strategy in a specific MATCH in which all the ALLIANCE members are participants.

Violation: Verbal warning plus YELLOW CARD if subsequent violations occur during the event.

Example 1: A MATCH is being played by Teams A and B, in which Team B is encouraged by Team D to not achieve a LEVEL 3 ASCENT. Team B accepts this request. Team D's motivation for this behavior is to prevent Team A from rising in the tournament rankings and negatively affecting Team D's ranking. Team B has violated this rule.

Example 2: A MATCH is being played by Teams A and B, in which Team A is assigned to participate as a SURROGATE. Team A accepts Team D's request to not participate in the MATCH so that Team D gains ranking position over Team B. Team A has violated this rule.

FIRST considers the action of a team influencing another team to throw a MATCH, to deliberately miss RANKING POINTS, etc. incompatible with FIRST values and not a strategy any team should employ.

G205 *Throwing your own MATCH is bad. A team may not intentionally lose a MATCH in an effort to lower their own ranking and/or manipulate the rankings of other teams.

Violation: Verbal warning plus YELLOW CARD if subsequent violations occur during the event.

The intent of this rule is not to punish teams who are employing alternate strategies, but rather to ensure that it is clear that throwing MATCHES to negatively affect your own rankings, or to manipulate the rankings of other teams (e.g., throw a MATCH to lower a partner's ranking, and/or increase the ranking of another team not in the MATCH) is incompatible with *FIRST* values and not a strategy any team should employ.

G206 *Do not abuse ARENA access. A team member (except those DRIVERS, HUMAN PLAYERS, and DRIVE COACHES on the DRIVE TEAM for the MATCH) granted access to restricted areas in and around the ARENA (e.g., via event issued media badges) may not assist, coach, or use signaling devices during the MATCH. Exceptions will be granted for inconsequential infractions and in cases concerning safety.

Violation: Verbal warning plus YELLOW CARD if subsequent violations occur during the event.

Team members in open-access spectator seating areas are not considered to be in a restricted area and are not prevented from assisting or using signaling devices. See [E102](#) for related details.

G207 *Show up to your MATCHES. If a ROBOT has passed initial, complete inspection, at least 1 member of its DRIVE TEAM must report to the ARENA and participate in each of their assigned qualification MATCHES.

Violation: DISQUALIFIED from the current MATCH.

The team should inform the lead Queuer if the team's ROBOT is not able to participate.

G208 *Enter only 1 ROBOT. Each registered *FIRST* Tech Challenge team may enter only 1 ROBOT (or "robot," a ROBOT-like assembly equipped with most of its CHASSIS, i.e., A ROBOT'S MAJOR MECHANISM that enables it to move around a FIELD) into a *FIRST* Tech Challenge event. Each registered *FIRST* Tech Challenge team may only participate in one concurrent event at a time.

Violation: Verbal warning plus RED CARD if not corrected.

"Entering" a ROBOT (or robot) into a *FIRST* Tech Challenge means bringing it to or using it at the event such that it is an aid to your team (e.g., for spare parts, judging material, or for practice).

While "most of its drive base" is a subjective assessment, for the purposes of this rule, an assembly whose drive base is missing all wheels/treads, gearboxes, and belts/chains is not considered a "ROBOT." If any of those COMPONENTS are incorporated, the assembly is now considered a "ROBOT."

This rule does not prohibit teams from bringing in ROBOTS from other *FIRST* programs for the purposes of awards presentations or pit displays.

It is expected that teams will update, make changes and may even build multiple ROBOTS in the course of a season, this rule only applies to bringing multiple different ROBOTS to a single event.

G209 *Keep your ROBOT together. A ROBOT may not intentionally detach or leave a part on the FIELD.

Violation: RED CARD.

G210 *Do not expect to gain by doing others harm. Actions clearly aimed at forcing the opponent ALLIANCE to violate a rule are not in the spirit of FIRST Tech Challenge and not allowed. Rule violations forced in this manner will not result in an assignment of a penalty to the targeted ALLIANCE.

Violation: MINOR FOUL plus MAJOR FOUL if REPEATED. The ALLIANCE that was forced to break a rule will not incur a FOUL.

This rule does not apply for strategies consistent with standard gameplay, for example:

- A. a red ALLIANCE ROBOT in their ASCENT ZONE in the final 30 seconds of the MATCH contacts a blue ALLIANCE ROBOT
- B. a red ROBOT attempts to enter their NET ZONE to place a SPECIMEN and pushes a blue ROBOT that was less than 1 TILE away into the NET ZONE.

This rule requires an intentional act with limited or no opportunity for the team being acted on to avoid the penalty, such as:

- A. trapping an opposing ALLIANCE ROBOT in your ALLIANCE'S ASCENT ZONE during the last 30 seconds of the MATCH.
- B. pushing an opposing ALLIANCE ROBOT into your ALLIANCE'S OBSERVATION ZONE intentionally or from more than 1 TILE away.
- C. placing your ALLIANCE SPECIFIC SAMPLE or SPECIMEN in an opposing ALLIANCE'S ROBOT.
- D. a ROBOT becomes pinned in their opposing ALLIANCE'S OBSERVATION ZONE by the opposing ALLIANCE ROBOT

G211 *Egregious or exceptional violations. Egregious behavior beyond what is listed in the rules or subsequent violations of any rule or procedure during the event is prohibited.

In addition to rule violations explicitly listed in this manual and witnessed by a REFEREE, the Head REFEREE may assign a YELLOW or RED CARD for egregious ROBOT actions or team member behavior at any time during the event.

Continued violations will be brought to FIRST Headquarters' attention. FIRST Headquarters will work with event staff to determine if further escalations are necessary, which can include removal from award consideration and removal from the event.

Please see section [10.6.1 YELLOW and RED CARDS](#) for additional detail.

Violation: YELLOW or RED CARD.

The intent of this rule is to provide the Head REFEREES with the flexibility necessary to keep the event running smoothly, as well as keep the safety of all the participants as the highest priority. There are certain behaviors that automatically result in a YELLOW or RED CARD because this behavior puts the

FIRST community at risk. Those behaviors include, but are not limited to the list below:

- A. inappropriate behavior as outlined in the orange box of [G201](#),
- B. reaching into the FIELD and grabbing a ROBOT during a MATCH,
- C. PINNING in excess of 15 seconds,

The Head REFEREE may assign a YELLOW or RED CARD for a single instance of a rule violation such as the examples given in items above, or for multiple instances of any single rule violation. Teams should be aware that any rule in this manual could escalate to a YELLOW or RED CARD. The Head REFEREE has final authority on all rules and violations at an event.

11.3 Pre-MATCH

G301 ***Be prompt.** A DRIVE TEAM member may not cause significant delays to the start of their MATCH. Causing a significant delay requires both of the following to be true:

- A. The expected MATCH start time has passed, and

During Qualification MATCHES, the expected start time of the MATCH is the time indicated on the MATCH schedule or ~3 minutes from the end of the previous MATCH on the same FIELD, whichever is later. If [T206](#) is in effect, the expected MATCH start time is the later of the end of the [T206](#) time or the time indicated on the schedule.

During playoff MATCHES, the expected start time of the MATCH is the time indicated on the MATCH schedule or 8 minutes from either ALLIANCE'S previous MATCH, whichever is later.

- B. The DRIVE TEAM has access to the ARENA and is neither MATCH ready nor making a good faith effort, as perceived by the Head REFEREE, to quickly become MATCH ready.

Teams that have violated [G207](#) or have 1 DRIVE TEAM member present and have informed event staff that their ROBOT will not be participating in the MATCH are considered MATCH ready and not in violation of this rule.

Violation: Verbal warning plus a MAJOR FOUL if subsequent violations occur within the tournament phase (e.g., qualifications or playoffs), and is applied to their upcoming MATCH. If the DRIVE TEAM is not MATCH ready within 2 minutes of the verbal warning/MAJOR FOUL and the Head REFEREE perceives no good faith effort by the DRIVE TEAM to quickly become MATCH ready, DISABLED.

The intent of this rule is to provide an equitable amount of time for both ALLIANCES to prepare for each MATCH and give DRIVE TEAMS grace given extenuating circumstances that cause them to be late.

Once a verbal warning/MAJOR FOUL is issued, the Head REFEREE starts a 2-minute timer and makes a good faith effort to share the timer's status with the delaying DRIVE TEAM.

Being "MATCH ready" requires that the ROBOT is on the FIELD, in its STARTING CONFIGURATION, and turned on. Additionally, the DRIVE TEAM members must be in their starting positions.

In general, good faith efforts to quickly become MATCH ready are entirely for the purposes of transitioning the ROBOT into a MATCH ready state (i.e., not attempts to significantly alter a ROBOT'S capabilities.) Examples of good faith efforts to quickly become MATCH ready include but are not limited to:

- A. walking safely towards the FIELD with a ROBOT that a team is not actively modifying.
- B. applying quick fixes such as tape or cable ties to make the ROBOT compliant with STARTING CONFIGURATION requirements.
- C. waiting for a DRIVER STATION device to boot.

G302 *You can only bring/use specific items to the MATCH. The only equipment that may be brought to the ARENA for a MATCH is listed below. Regardless of if equipment fits criteria below, it may not be employed in a way that breaks any other rules, introduces a safety hazard, blocks visibility for FIELD STAFF or audience members, or jams or interferes with the remote sensing capabilities of another team or the FIELD.

- A. the ROBOT
- B. the OPERATOR CONSOLE
- C. ROBOT carts (which may contain basic tools and supplies to maintain the ROBOT)
- D. non-powered signaling devices
- E. reasonable decorative items
- F. special clothing and/or equipment required due to a disability
- G. devices (e.g., laptop, tablet, phone, camera, etc.) used solely for planning, tracking, recording, and communicating strategy within the same designated area (e.g., ALLIANCE AREA)
- H. this letter intentionally left blank
- I. non-powered Personal Protective Equipment (examples include, but aren't limited to, gloves, eye protection, and hearing protection)

Items brought to the ARENA under allowances D-I must meet all following conditions:

- I. does not connect or attach to another ALLIANCE member (other than items in category I).
- II. does not communicate with anything or anyone outside of the ARENA.
- III. does not include any form of enabled wireless electronic communication with the exception of medically required equipment.
- IV. does not in any way affect the outcome of a MATCH, other than by allowing the DRIVE TEAM to
 - a. plan or track strategy for the purposes of communication of that strategy to other ALLIANCE members or
 - b. use items allowed per D to communicate with the ROBOT.

Violation: MATCH will not start until the situation is remedied. If discovered or used inappropriately during a MATCH, YELLOW CARD.

Use of imagery that, to a reasonably astute observer, mimics the AprilTags employed on the FIELD is a violation of this rule.

Examples of wireless communication include, but are not limited to, radios, walkie-talkies, cell phones, Bluetooth communications, and Wi-Fi.

G303 ***ROBOTS on the FIELD must be set up to play a MATCH.** A ROBOT must meet all following MATCH-start requirements:

- A. does not pose a hazard to humans, FIELD elements, or other ROBOTS.
- B. has passed inspection, i.e., it is compliant with all ROBOT rules.
- C. if modified after initial Inspection, it is compliant with [I304](#).
- D. is the only team-provided item left on the FIELD.
- E. is fully contained within the FIELD and not in the NET ZONE or OBSERVATION ZONE.
- F. touching the FIELD wall adjacent to the ALLIANCE AREA.
- G. not attached to, entangled with, or suspended from any FIELD element.
- H. confined to its STARTING CONFIGURATION (see [R101](#) and [R102](#)).
- I. in contact with no more than the allowed pre-load possession limit as described in section [10.3.1 SCORING ELEMENTS](#).
- J. ROBOT SIGNS must indicate the correct ALLIANCE color (see [R101](#)).
- K. ROBOT must be motionless following completion of OpMode initialization.

If a ROBOT is DISABLED prior to the start of the MATCH, the DRIVE TEAM may not remove the ROBOT from the FIELD without permission from the Head REFEREE or the FTA.

For assessment of many of the items listed above, the Head REFEREE is likely to consult with the LRI.

Violation: If there is a quick remedy, the MATCH will not start until all requirements are met. If it is not a quick remedy, DISABLED and, at the discretion of the Head REFEREE, ROBOT must be re-inspected. If a ROBOT not compliant with part [B](#) or [C](#) participates, its team receives a RED CARD.

G304 ***Teams must select an OpMode.** An OpMode must be selected on the DRIVER STATION app and initialized by pressing the INIT button. If this OpMode is an AUTO OpMode, the 30 second AUTO timer must be enabled.

Violation: MATCH will not start until the situation is remedied. If ROBOT cannot initialize an OpMode or the situation cannot be remedied quickly, DISABLED.

This rule requires all teams to select and INIT an OpMode regardless of whether or not an AUTO OpMode is planned to be used during AUTO. FIELD STAFF will use this as an indication that a team is ready to start the MATCH.

Teams without an AUTO OpMode should consider creating a default AUTO OpMode using the BasicOpMode sample and use the [auto-loading feature](#) to automatically queue up their TELEOP OpMode.

11.4 In-MATCH

Rules in this section pertain to gameplay once a MATCH begins.

11.4.1 AUTO

The AUTO period is the first 30 seconds of the MATCH, during which DRIVERS may not provide input to their ROBOTS, so ROBOTS operate with only their pre-programmed instructions. Rules in this section apply only during the AUTO period.

G401 *Let the ROBOT do its thing. In AUTO, a DRIVE TEAM member may not directly or indirectly interact with a ROBOT or an OPERATOR CONSOLE, with the following exceptions:

- A. to press the (▶) start button at the start of the MATCH.
- B. to press the (■) stop button before the end of AUTO either at the team's discretion or instruction of the Head REFEREE per [T202](#).
- C. for personal safety or OPERATOR CONSOLE safety.

Violation: MAJOR FOUL.

G402 *Start AUTO on time. If a team chooses to run an AUTO OpMode during the AUTO period, a DRIVE TEAM member must press the (▶) start button on their DRIVER STATION app within a MOMENTARY delay of the start of the MATCH. This rule does not apply if the (▶) start button is not pressed during AUTO.

Violation: MAJOR FOUL plus YELLOW CARD if subsequent violations occur during the event.

G403 *OpModes are stopped by the end of AUTO. ROBOTS must no longer be running an AUTO OpMode by the end of the AUTO period. This can be done by a DRIVE TEAM member pressing the (■) stop button on the DRIVER STATION app, allowing the OpMode to naturally end, or allowing the 30 second AUTO timer to end the OpMode.

Violation: MINOR FOUL or MAJOR FOUL if actions result in a scoring achievement by the offending ROBOT.

G404 No AUTO opponent interference. FIELD columns A, B, C constitute the blue side of the FIELD, and columns D, E, F (Figure 9-4) constitute the red side of the FIELD. During AUTO ROBOTS may not:

- A. contact an opposing ALLIANCE'S ROBOT which is completely within the opposing ALLIANCE'S half of the FIELD.
- B. contact a pre-set SAMPLE on the opposing ALLIANCE'S half of the FIELD.
- C. move SCORING ELEMENTS onto the opposing ALLIANCE'S half of the FIELD outside of the SUBMERSIBLE ZONE.

Violation: MAJOR FOUL each occurrence.

The intent of this rule is to protect ROBOT actions performed while completely in their ALLIANCE'S side of the FIELD. Navigating into the opposing ALLIANCE'S side of the FIELD during AUTO is a risky gameplay strategy.

11.4.2 TELEOP

G405 ***ROBOTS are motionless between AUTO and TELEOP.** Any powered movement of the ROBOT or any of its MECHANISMS is not allowed during the transition period between AUTO and TELEOP.

Violation: MAJOR FOUL plus YELLOW CARD if subsequent violations occur during the event.

Movement that occurs following the conclusion of an AUTO OpMode (due to inertia, gravity, or de-energizing of actuators, etc.) is not a violation of this rule.

Teams may press buttons on their DRIVER STATION app to initialize or start a TELEOP OpMode during the AUTO to TELEOP transition period. If the INIT portion of the OpMode causes the ROBOT to violate this rule (actuators moving or twitching in any way) then the team should wait until the TELEOP period begins before pressing INIT.

G406 ***ROBOTS are motionless at the end of TELEOP.** ROBOTS must no longer be actively controlled by DRIVERS after the end of the TELEOP period. This can be done by a DRIVE TEAM member pressing the (■) stop button on the DRIVER STATION app or by discontinuing any operation of the ROBOT by the end of the MATCH period.

Violation: MINOR FOUL or MAJOR FOUL if actions result in a scoring achievement by the offending ROBOT.

DRIVE TEAMS should make their best effort to stop gameplay immediately at the end of the MATCH period. The end of MATCH period buzzer audio cue is approximately 3 seconds long and is used as an unofficial indicator to teams and REFEREES that the MATCH has ended.

11.4.3 SCORING ELEMENT

G407 ***ROBOTS use SCORING ELEMENT as directed.** A ROBOT may not deliberately use a SCORING ELEMENT in an attempt to ease or amplify a challenge associated with a FIELD element other than as intended.

Violation: MAJOR FOUL per SCORING ELEMENT.

Examples include, but are not limited to:

- A. placing SCORING ELEMENTS on other ROBOTS,
- B. using SCORING ELEMENTS to elevate ROBOTS in an attempt to ASCEND the RUNGS of the SUBMERSIBLE, and
- C. positioning SCORING ELEMENTS to impede opponent access to FIELD elements.

G408 ***Keep SCORING ELEMENTS in bounds.** A ROBOT may not intentionally eject a SCORING ELEMENT from the FIELD (either directly or by bouncing off a FIELD element or another ROBOT). SCORING ELEMENTS that leave the FIELD are not returned to gameplay except as allowed in rule [G431](#).

Violation: MAJOR FOUL per SCORING ELEMENT.

SCORING ELEMENTS removed from the FIELD while attempting to score are not a violation of this rule, however, are not returned to the FIELD.

G409 ***Do not damage SCORING ELEMENTS.** Neither a ROBOT nor a HUMAN PLAYER may damage a SCORING ELEMENT.

Violation: Verbal warning plus MAJOR FOUL if REPEATED. If the damage is caused by a ROBOT, and the Head REFEREE determines that further damage is likely to occur, DISABLED. The ROBOT will then be required to pass reinspection before competing in subsequent MATCHES.

SCORING ELEMENTS are expected to undergo a reasonable amount of wear and tear as they are handled by ROBOTS and humans, such as scratching, marking, and eventually damage due to fatigue. Routinely gouging, tearing off pieces, or marking SCORING ELEMENTS are violations of this rule.

G410 **1 SAMPLE or SPECIMEN at a time.** A ROBOT may not CONTROL more than 1 SAMPLE or 1 SPECIMEN at a time, either directly or transitively through other objects. There is no limit to the number of CLIPS a ROBOT may possess.

A ROBOT is in CONTROL of a SAMPLE or SPECIMEN if:

- A. the SAMPLE or SPECIMEN is fully supported by the ROBOT or
- B. it intentionally pushes a SAMPLE or SPECIMEN to a desired location or in a preferred direction (i.e., herding, often with a concave surface)

Exceptions to this rule are as follows:

- C. ROBOTS may MOMENTARILY exceed CONTROL limits while collecting SAMPLES that are in the SUBMERSIBLE ZONE.
- D. scored SAMPLES or SPECIMENS for the corresponding ALLIANCE are exempt from the CONTROL limit.

Violation: MINOR FOUL per additional SAMPLE and/or SPECIMEN plus YELLOW CARD if excessive.

Examples of interaction with a SAMPLE or SPECIMEN that are not “CONTROL” include, but are not limited to:

- A. PLOWING or “bulldozing” (inadvertent contact with a SAMPLE or SPECIMEN, typically via a flat or convex surface, while in the path of the ROBOT moving about the FIELD).
- B. “deflecting” (being hit by a SAMPLE or SPECIMEN that bounces off a ROBOT).

Excessive violations of CONTROL limits include, but are not limited to, simultaneous CONTROL of 3 or more SAMPLES and/or SPECIMENS, or frequent, greater-than MOMENTARY CONTROL (i.e., more than twice in a MATCH) of 2 or more SAMPLES and/or SPECIMENS. REPEATED excessive violations of this rule do not result in additional YELLOW CARDS unless the violation reaches the level of egregious to trigger a [G201](#) violation.

G411 **ROBOTS may not CONTROL the opposing ALLIANCE’S SPECIFIC SAMPLES or SPECIMENS.** ROBOTS may only have MOMENTARY CONTROL of opposing ALLIANCE SPECIFIC SAMPLES or SPECIMENS.

Violation: MINOR FOUL per SCORING ELEMENT plus an additional MINOR FOUL per opposing SCORING ELEMENT for each 5-second interval that the situation continues. A MAJOR FOUL is applied for each SCORING ELEMENT that is scored while in CONTROL.

G412 **ROBOTS may not de-score opposing ALLIANCE SCORING ELEMENTS.** ROBOTS may not affect the following opposing ALLIANCE achievements.

- A. removal of SAMPLES from the NET ZONE
- B. removal of SAMPLES from the BASKETS
- C. removal of SPECIMENS that are fully clipped onto the CHAMBERS.

SPECIMENS that are not fully clipped onto a CHAMBER and are de-scored from a CHAMBER during normal ROBOT interactions with the SUBMERSIBLE are not penalized.

A SPECIMEN that is taken apart while scored onto the CHAMBER is a violation of this rule and does incur a FOUL.

Violation: MAJOR FOUL per SCORING ELEMENT that is de-scored.

11.4.4 ROBOT

G413 ***ROBOTS must be safe.** A ROBOT may not pose an undue hazard to a human, an ARENA element, or another ROBOT in the following ways:

- A. the ROBOT or anything it CONTROLS, i.e., a SCORING ELEMENT, contacts anything outside the FIELD.
- B. its operation or design is dangerous or unsafe.

Violation: YELLOW CARD and DISABLED if unsafe or CONTINUOUS.

Examples of dangerous operation or designs that likely pose undue hazards include, but are not limited to:

- A. uncontrolled motion that cannot be stopped by the DRIVE TEAM,
- B. ROBOT parts “flailing” outside of the FIELD,
- C. ROBOTS dragging their battery, and
- D. ROBOTS that consistently extend outside the FIELD.

Please be conscious of REFEREES and FIELD STAFF working around the ARENA who may be in close proximity to your ROBOT.

G414 ***ROBOTS must stop when instructed.** If a team is instructed to DISABLE their ROBOT by a REFEREE per [T202](#), a DRIVE TEAM member must press the (■) stop button on the DRIVER STATION app.

Violation: if more than MOMENTARY delay MAJOR FOUL, plus RED CARD if CONTINUOUS.

G415 ***ROBOTS must be identifiable.** A ROBOT’S team number and ALLIANCE color must not become indeterminate by determination of the Head REFEREE.

Violation: Verbal warning plus YELLOW CARD if subsequent violations occur during the event.

Teams are encouraged to robustly affix their ROBOT SIGNS to their ROBOT in highly visible locations such that they do not easily fall off or become obscured during normal gameplay.

G416 ***Watch your ARENA interaction.** With the exception of SCORING ELEMENTS (per [G409](#)), ROBOTS may not damage any ARENA elements.

ROBOTS are also prohibited from the following interactions with an ARENA element, except for SCORING ELEMENTS and their ALLIANCE'S RUNGS:

- A. grabbing
- B. grasping
- C. attaching to
- D. becoming entangled with, and
- E. suspending from

Scoring SPECIMENS on CHAMBERS does not constitute a violation of this rule.

Violation: Verbal warning plus YELLOW CARD if REPEATED or longer than MOMENTARY, and for any subsequent damage during the MATCH or event. If the Head REFEREE infers that damage is likely, DISABLED. Corrective action (such as eliminating sharp edges, removing the damaging MECHANISM, and/or reinspection) may be required before the ROBOT will be allowed to compete in subsequent MATCHES.

G417 **Stay in CONTROL of your SCORING ELEMENTS.** SCORING ELEMENTS may not be LAUNCHED.

Violation: MINOR FOUL per SCORING ELEMENT LAUNCHED.

This rule is intended to prevent designs which use LAUNCHING to strategically play the game. Actions that can be perceived as strategically playing the game include, but are not limited to:

- A. Moving SCORING ELEMENTS from the ROBOT from outside of an AREA or ZONE to inside another AREA or ZONE with significant force/traveling more than a short distance.

This is not intended to penalize teams with active manipulators which are expelling SCORING ELEMENTS through normal operation, such as

- A. Running an intake in reverse causing a SCORING ELEMENT to travel a short distance from the ROBOT.
- B. A ROBOT pushing a SCORING ELEMENT a short distance away in the process of herding it across the FIELD.

G418 Horizontal expansion limit. After the MATCH has started, ROBOTS may expand beyond the STARTING CONFIGURATION but are still subject to sizing constraints. The sizing constraints are specified in [R104](#)).

Violation: if more than MOMENTARY, MINOR FOUL, or MAJOR FOUL if the over-expansion is used for strategic benefit, including if it impedes or enables a scoring action.

This rule is intended to limit the amount of floor area each ROBOT can cover with the maximum range of motion of all extensions. All possible movement of extensions outside the STARTING CONFIGURATION must be constrained as described in [R104](#).

During the MATCH REFEREES may use ARENA elements to help gauge ROBOT expansion during the MATCH. For example:

- A. TILES are approximately 24 in. (~61 cm)
- B. The RUNGS on the SUBMERSIBLE are 44.5 in. (~113 cm) wide

G419 Watch out for Humans. A ROBOT may not:

- A. enter the OBSERVATION ZONE while a HUMAN PLAYER is in the OBSERVATION ZONE.
- B. contact a SCORING ELEMENT, either directly or transitively, that is controlled/possessed by a HUMAN PLAYER.

Violation: MINOR FOUL per occurrence plus YELLOW CARD if the ROBOT contacts the HUMAN PLAYER.

[G419](#), [G431](#), and [G432](#) do not stack. One FOUL should be called per occurrence of the violation per ALLIANCE. For example, two FOULS would be called in the case where the ROBOT and HUMAN PLAYER are on separate ALLIANCES.

G420 No climbing on the inside. ROBOTS must start their ASCENT with their CHASSIS completely outside the SUBMERSIBLE ZONE.

Violation: MAJOR FOUL and team will not receive credit for ASCENT scoring outlined in section 10.5.3.

The purpose of this rule is to limit how much of the ROBOT may be inside the SUBMERSIBLE ZONE before the ASCENT begins. ROBOT elements are allowed to reach into the SUBMERSIBLE ZONE while attempting to ASCEND, as long as the ROBOT CHASSIS remains completely outside the SUBMERSIBLE ZONE. It is expected that there will be some contact between opponent ROBOTS within the SUBMERSIBLE ZONE, and this is intended to minimize the extent of that contact.

11.4.5 Opponent Interaction

Note, [G421](#) and [G422](#) are mutually exclusive. A single ROBOT to ROBOT interaction which violates more than one of these rules results in the most punitive penalty, and only the most punitive penalty, being assessed.

G421 *This is not combat robotics. A ROBOT may not deliberately damage or deliberately functionally impair an opponent ROBOT as perceived by a REFEREE.

Damage or functional impairment because of contact with a tipped-over or DISABLED opponent ROBOT, which is not perceived by a REFEREE to be deliberate, is not a violation of this rule.

Violation: MAJOR FOUL and YELLOW CARD, or if opponent ROBOT is unable to drive, then MAJOR FOUL and RED CARD.

FIRST Tech Challenge can be a high-contact competition and may include rigorous gameplay. While this rule aims to limit severe damage to ROBOTS, teams should design their ROBOTS to be robust. Teams are expected to act responsibly.

Examples of violations of this rule include, but are not limited to:

- A. A ROBOT high-speed rams and/or REPEATEDLY smashes an opponent ROBOT and causes damage. The REFEREE infers that the ROBOT was deliberately trying to damage the opponent's ROBOT.

At the conclusion of the MATCH, the Head REFEREE may elect to visually inspect a ROBOT to confirm violations of this rule made during a MATCH and remove the violation if the damage cannot be verified.

"Unable to drive" means that because of the incident, the DRIVER can no longer drive to a desired location in a reasonable time (generally). For example, if a ROBOT can only move in circles, or can only move extremely slowly, the ROBOT is considered unable to drive.

G422 *Do not tip or entangle. A ROBOT may not deliberately, as perceived by a REFEREE, attach to, tip, or entangle an opponent ROBOT.

Violation: MAJOR FOUL and YELLOW CARD, or if CONTINUOUS or opponent ROBOT is unable to drive, then MAJOR FOUL and RED CARD.

Examples of violations of this rule include, but are not limited to:

- A. using a wedge-like MECHANISM to tip over an opponent ROBOT
- B. making frame-to-frame contact with an opponent ROBOT that is attempting to right itself after previously falling over and causing them to fall over.
- C. causing an opponent ROBOT to tip over by contacting the ROBOT after it starts to tip if, in the judgement of the REFEREE, that contact could have been avoided.

Tipping as an unintended consequence of normal ROBOT-to-ROBOT interaction, including single frame-to-frame hits that result in a ROBOT tipping, as perceived by the REFEREE, is not a violation of this rule.

"Unable to drive" means that because of the incident, the DRIVER can no longer drive to a desired location in a reasonable time (generally). For example, if a ROBOT can only move in circles, or can only move extremely slowly, the ROBOT is considered unable to drive.

G423 *There is a 5-count on PINS. A ROBOT may not PIN an opponent's ROBOT for more than 5 seconds. A ROBOT is PINNING if it is preventing the movement of an opponent ROBOT by contact, either direct or transitive (such as against a FIELD element) and the opponent ROBOT is attempting to move. A PIN count ends once any of the following criteria below are met:

- A. the ROBOTS have separated by at least 2 ft. (~61 cm) from each other for more than 5 seconds,
- B. either ROBOT has moved 2 ft. from where the PIN initiated for more than 5 seconds, or
- C. the PINNING ROBOT gets PINNED.

For criteria A, the PIN count pauses once ROBOTS are separated by 2 ft. until either the PIN ends or the PINNING ROBOT moves back within 2 ft., at which point the PIN count is resumed.

For criteria B, the PIN count pauses once either ROBOT has moved 2ft from where the PIN initiated until the PIN ends or until both ROBOTS move back within 2ft., at which point the PIN count is resumed.

Violation: MINOR FOUL plus an additional MINOR FOUL for every 5 seconds in which the situation is not corrected.

G424 *Do not use strategies intended to shut down major parts of gameplay. A ROBOT or ROBOTS may not, in the judgment of a REFEREE, isolate or close off any major element of MATCH play for a greater-than-MOMENTARY duration.

Violation: MINOR FOUL plus an additional MINOR FOUL for every 5 seconds in which the situation is not corrected.

Examples of violations of this rule include, but are not limited to:

- A. shutting down access to all SCORING ELEMENTS,
- B. quarantining an opponent to a small area of the FIELD,
- C. quarantining SCORING ELEMENTS out of the opposing ALLIANCE'S reach,
- D. blocking all access to the opponent's BASKETS, NET ZONE, CHAMBERS, or OBSERVATION ZONE, and
- E. blocking all access to SCORING ELEMENTS in the SUBMERSIBLE ZONE

G425 NET ZONE Protection. A ROBOT may not contact (either directly or transitively through a SCORING ELEMENT CONTROLLED by either ROBOT, regardless of who initiates contact) an opponent ROBOT if any part of either ROBOT is in the opponent's NET ZONE.

Violation: MAJOR FOUL per occurrence.

G426 OBSERVATION ZONE Protection. A ROBOT may not be in the opposing ALLIANCE'S OBSERVATION ZONE. A ROBOT that is being PINNED is exempt from this rule.

Violation: MINOR FOUL plus MINOR FOUL for every 5 seconds the violation continues. Additional MINOR FOUL for every SCORING ELEMENT contacted inside the OBSERVATION ZONE.

In the scenario where a ROBOT is being PINNED in their opponent's OBSERVATION ZONE, REFEREES are instructed to disregard [G426](#) and focus on the PINNING.

G427 Climbing ROBOTS are protected. In the last 30 seconds of the MATCH, a ROBOT may not contact (either directly or transitively through a SCORING ELEMENT CONTROLLED by either ROBOT and regardless of who initiates contact) an opponent ROBOT if any part of either ROBOT is in the opponent's ASCENT ZONE. Exceptions to this rule are as follows:

- A. Contact occurring while both ROBOTS have achieved LEVEL 2 or LEVEL 3 ASCENT.

Violation: MAJOR FOUL plus the affected ALLIANCE ROBOT is awarded a LEVEL 3 ASCENT.

Teams should be aware that the SUBMERSIBLE ZONE is a constrained space and ROBOTS swinging during their ASCENT may contact each other and teams should design their ROBOTS to be resilient to incidental contact.

ROBOTS that are attempting to play defense within the SUBMERSIBLE ZONE or the ASCENT ZONES during the last 30 seconds of the MATCH are likely to incur penalties.

11.4.6 Human

G428 *No wandering. DRIVE TEAM members must remain in their designated ALLIANCE AREA.

- A. DRIVE TEAMS may be anywhere in their respective ALLIANCE AREA during a MATCH.
- B. DRIVE TEAM members must be staged inside their respective ALLIANCE AREA prior to MATCH start.

The intent of this rule is to prevent DRIVE TEAM members from leaving their assigned AREA during a MATCH to gain a competitive advantage. For example, moving to another part of the FIELD for better viewing, reaching into the FIELD, etc. Simply breaking the plane of the AREA during normal MATCH play is not a FOUL.

Exceptions are granted in cases concerning safety and for actions that are inadvertent, MOMENTARY, and inconsequential.

Violation: Verbal warning plus a MINOR FOUL if subsequent violations occur at any point during the event.

G429 *DRIVE COACHES and other teams: hands off the controls. A ROBOT shall be operated only by the DRIVERS of that team, DRIVE COACHES may not handle the gamepads. DRIVE COACHES, if desired, may help the DRIVERS in the following ways:

- A. holding the DRIVER STATION device,
- B. troubleshooting the DRIVER STATION device,
- C. selecting OpModes on the DRIVER STATION app,
- D. pressing the INIT button on the DRIVER STATION app,
- E. pressing the (▶) start button on the DRIVER STATION app, or
- F. pressing the (■) stop button on the DRIVER STATION app.

Violation: MAJOR FOUL plus YELLOW CARD if greater-than-MOMENTARY.

Exceptions may be made before a MATCH for major conflicts, e.g., religious holidays, major testing, transportation issues, etc.

G430 ***DRIVE TEAMS, watch your reach.** Once a MATCH starts, a DRIVE TEAM member may not extend into the FIELD except as specifically allowed by [G431](#) and [G432](#).

Violation: MAJOR FOUL per occurrence plus YELLOW CARD if the DRIVE TEAM member contacts the ROBOT.

Exceptions are granted in cases concerning safety and for actions that are inadvertent, MOMENTARY, and inconsequential.

G431 **HUMAN PLAYERS manipulate SCORING ELEMENTS within limits.** Only the HUMAN PLAYER may introduce SCORING ELEMENTS into or retrieve SCORING ELEMENTS from the OBSERVATION ZONE.

- A. any number of SCORING ELEMENTS can be manipulated by the HUMAN PLAYER at a time.
- B. SCORING ELEMENTS may be placed in any orientation and/or in contact with other SCORING ELEMENTS.
- C. HUMAN PLAYERS may only place and/or retrieve SCORING ELEMENTS into the OBSERVATION ZONE during the AUTO and TELEOP periods of the MATCH.
- D. HUMAN PLAYERS may not be in contact with a SCORING ELEMENT, either directly or transitively, that is possessed/controlled by a ROBOT.
- E. HUMAN PLAYERS may reintroduce SCORING ELEMENTS to the OBSERVATION ZONE that have left the FIELD as a result of a ROBOT attempting to collect it from the OBSERVATION ZONE or FIELD wall within the OBSERVATION ZONE, as long as no other rules are violated (e.g. rule G428).
- F. HUMAN PLAYERS may manipulate opposing ALLIANCE SCORING ELEMENTS that have been placed into their ALLIANCE'S OBSERVATION ZONE. The opposing ALLIANCE SCORING ELEMENTS may not be removed from the OBSERVATION ZONE, but may be moved within the OBSERVATION ZONE.

Violation: MINOR FOUL per occurrence plus YELLOW CARD if the HUMAN PLAYER contacts the ROBOT.

SPECIMENS hung from the FIELD wall in the OBSERVATION ZONE are still considered in the OBSERVATION ZONE and may be manipulated by the HUMAN PLAYER.

[G419](#) and [G431](#) do not stack. One FOUL should be called per occurrence of the violation per ALLIANCE. For example, two FOULS would be called in the case where the ROBOT and HUMAN PLAYER are on separate ALLIANCES.

G432 **Watch out for ROBOTS.** A HUMAN PLAYER cannot break the vertical plane of the FIELD wall when a ROBOT is in the OBSERVATION ZONE. The only exceptions are:

- A. The ROBOT in the OBSERVATION ZONE has been declared DISABLED by a REFEREE.

Violation: MINOR FOUL per occurrence plus YELLOW CARD if the HUMAN PLAYER contacts the ROBOT.

[G419](#), [G431](#), and [G432](#) do not stack. One FOUL should be called per occurrence of the violation per ALLIANCE. For example, two FOULS would be called in the case where the ROBOT and HUMAN PLAYER are on separate ALLIANCES.

Debris or detached ROBOT parts may be retrieved from the OBSERVATION ZONE by a HUMAN PLAYER.

G433 HUMAN PLAYERS may not yeet SCORING ELEMENTS. HUMAN PLAYERS may not cause SCORING ELEMENTS to exit the OBSERVATION ZONE into the remainder of the FIELD.

HUMAN PLAYERS should take care when releasing SCORING ELEMENTS into the OBSERVATION ZONE. The final resting place of the SCORING ELEMENTS is the responsibility of the HUMAN PLAYER, regardless of what the SCORING ELEMENTS hits as it is released.

Violation: MAJOR FOUL per SCORING ELEMENT.

G434 No tools to introduce or retrieve SCORING ELEMENTS. The HUMAN PLAYER may not use a tool to manipulate a SCORING ELEMENT.

Violation: MINOR FOUL per occurrence.

Accommodations and/or exceptions for HUMAN PLAYERS with a disability and/or an extenuating circumstance will be made at the discretion of the head REFEREE and/or Event Director.

11.5 Post-MATCH

G501 *Leave promptly. A DRIVE TEAM member may not cause significant or multiple post-MATCH delays.

Violation: Verbal warning plus YELLOW CARD if subsequent violations occur at any point during the event.

G502 *Stop ROBOTS before entering the FIELD. DRIVE TEAM members may not enter the FIELD to recover ROBOTS until:

- A. the Head REFEREE has signaled it is okay to enter the field and
- B. the DRIVE TEAM has pressed the (■) stop button on their DRIVER STATION app

Violation: Verbal warning plus YELLOW CARD if subsequent violations occur at any point during the event.



12 ROBOT Construction Rules (R)

The rules listed below explicitly address legal parts and materials and how those parts and materials may be used on a ROBOT. A ROBOT is an electromechanical assembly built by the *FIRST* Tech Challenge team to play the current season's game and includes all the basic systems required to be an active participant in the game –power, communications, control, and movement about the FIELD.

There are many reasons for the structure of the rules, including safety, reliability, parity, creation of a reasonable design challenge, adherence to professional standards, and impact on the competition.

Another intent of these rules is to have all energy sources and active actuation systems on the ROBOT (e.g., batteries, motors, servos, and their controllers) drawn from a well-defined set of options. This is to ensure that all teams have access to the same actuation resources and that the INSPECTORS can accurately and efficiently assess the legality of a given part.

ROBOT construction rules in this section only apply to the construction of your ROBOT as it might be inspected. MATCH play rules and consequences for violating rules during MATCH play are outlined in section [11 Game Rules \(G\)](#).

ROBOTS are made up of COMPONENTS and MECHANISMS. A COMPONENT is any part in its most basic configuration, which cannot be disassembled without damaging or destroying the part or altering its fundamental function. A MECHANISM is an assembly of COMPONENTS that provide specific functionality on the ROBOT. A MECHANISM can be disassembled (and then reassembled) into individual COMPONENTS without damage to the parts.

Many rules in this section reference Commercial-Off-The-Shelf (COTS) items. A COTS item must be a standard (i.e., not custom order) part commonly available from a VENDOR for all teams for purchase. To be a COTS item, the COMPONENT or MECHANISM must be in an unaltered, unmodified state (with the exception of installation or modification of any software). Items that are no longer commercially available but are functionally equivalent to the original condition as delivered from the VENDOR are considered COTS and may be used.

Example 1: A team orders 2 ROBOT panels from RoboPanels Corp. and receives both items. They put 1 in their storeroom and plan to use it later. Into the other, they drill "lightening holes" to reduce weight. The first panel is still classified as a COTS item, but the second panel is now a FABRICATED ITEM, as it has been modified.

Example 2: A team obtains openly available blueprints of a drive module commonly available from Wheels-R-Us Inc. and has local machine shop "We-Make-It, Inc." manufacture a copy of the part for them. The produced part is not a COTS item, because it is not commonly carried as part of the standard stock of We-Make-It, Inc.

Example 3: A team obtains openly available design drawings from a professional publication and uses them to fabricate a gearbox for their ROBOT. The design drawings are considered a COTS item and may be used as "raw material" to fabricate the gearbox. The finished gearbox itself would be a FABRICATED ITEM, and not a COTS item.

Example 4: A COTS part that has non-functional label markings added would still be considered a COTS part, but a COTS part that has device-specific mounting holes added is a FABRICATED ITEM.

Example 5: A team has a COTS gearbox which has been discontinued. If the COTS gearbox is functionally equivalent to its original condition, it may be used.

A **VENDOR** is a legitimate business source for COTS items that satisfies all the following criteria:

- A. has a Federal Tax Identification number. In cases where the **VENDOR** is outside of the United States, they must possess an equivalent form of registration or license with the government of their home nation that establishes and validates their status as a legitimate business licensed to operate within that country.
- B. is not a “wholly owned subsidiary” of a *FIRST* team or collection of teams. While there may be some individuals affiliated with both a team and the **VENDOR**, the business and activities of the team and **VENDOR** must be completely separable.
- C. should maintain sufficient stock or production capability so they are able to ship any general (i.e., non-*FIRST* unique) product within a timely manner. It is recognized that certain unusual circumstances (such as a global supply chain disruption and/or 1,000 *FIRST* teams all ordering the same part at once from the same **VENDOR**) may cause atypical delays in shipping due to backorders for even the largest **VENDORS**. Such delays due to higher-than-normal order rates are excused. This criterion may not apply to custom-built items from a source that is both a **VENDOR** and a fabricator.

For example, a **VENDOR** may sell flexible belting that the team wishes to procure to use as treads on their drive system. The **VENDOR** cuts the belting to a custom length from standard shelf stock that is typically available, welds it into a loop to make a tread, and ships it to a team. The fabrication of the tread takes the **VENDOR** 2 weeks. This would be considered a FABRICATED ITEM, and the 2-week ship time is acceptable. Alternately, the team may decide to fabricate the treads themselves. To satisfy this criterion, the **VENDOR** would just have to ship a length of belting from shelf stock (i.e., a COTS item) to the team within 5 business days and leave the welding of the cuts to the team.

- D. makes their products available to all *FIRST* Tech Challenge teams. A **VENDOR** must not limit supply or make a product available to just a limited number of *FIRST* Tech Challenge teams.

The intent of this definition is to be as inclusive as possible to permit access to all legitimate sources, while preventing ad hoc organizations from providing special-purpose products to a limited subset of teams in an attempt to circumvent any applicable cost accounting rules.

FIRST desires to permit teams to have the broadest choice of legitimate sources possible, and to obtain COTS items from the sources that provide them with the best prices and level of service available. Teams also need to protect against long delays in availability of parts that will impact their ability to complete their **ROBOT**. The build season is brief, so the **VENDOR** must be able to get their product, particularly *FIRST* unique items, to a team in a timely manner.

Ideally, chosen VENDORS should have effective distribution channels. Remember, *FIRST* Tech Challenge events are not always near home – when parts fail, local access to replacement materials is often critical.

A FABRICATED ITEM is any COMPONENT or MECHANISM that has been altered, built, cast, constructed, concocted, created, cut, heat treated, machined, manufactured, modified, painted, produced, surface coated, or conjured partially or completely into the final form in which it will be used on the ROBOT.

Note that it is possible for an item (typically raw materials) to be neither COTS nor a FABRICATED ITEM. For example, a 20 ft. (~610 cm) length of aluminum which has been cut into 5 ft. (~152 cm) pieces by the team for storage or transport is neither COTS (it is not in the state received from the VENDOR), nor a FABRICATED ITEM (the cuts were not made to advance the part towards its final form on the ROBOT).

Teams may be asked to provide documentation (i.e., reference the relevant rule in this manual) proving the legality of items during inspection where a rule specifies limits for a legal part (e.g., motors, servos, current limits, COTS electronics).

Some of these rules make use of English unit requirements for parts. If your team has a question about a metric-equivalent part's legality, please e-mail your question to the *FIRST* Tech Challenge at firsttechchallenge@firstinspires.org for an official ruling. To seek approval for alternate parts/devices for inclusion in future *FIRST* Tech Challenge seasons, please use the [Part Suggestion Form](#).

FIRST Tech Challenge can be a high-contact competition and may include rigorous gameplay. While the rules aim to limit severe damage to ROBOTS, teams should design their ROBOTS to be robust.

12.1 General ROBOT Design

R101 ***STARTING CONFIGURATION is limited to an 18-inch Cube.** In the STARTING CONFIGURATION (the physical configuration in which a ROBOT starts a MATCH), the ROBOT must be fully self-contained within an 18-inch wide, by 18-inch long, by 18-inch-high volume. The only exceptions are:

- A. preloaded SCORING ELEMENTS may extend outside the starting size constraint.
- B. minor protrusions up to 0.25 inches (6.4 mm) by flexible materials (e.g., zip tie, surgical tube, string) may extend beyond the 18-inch (45.7 cm) size constraint.

If a ROBOT uses interchangeable MECHANISMS per [I303](#), teams should be prepared to show compliance with this rule and [R104](#) in all configurations.

R102 ***ROBOTS may assist in holding the STARTING CONFIGURATION.** In the STARTING CONFIGURATION, ROBOTS must be fully self-supported (i.e., does not exert force on the sides or top of a sizing tool). ROBOTS may accomplish this using any combination of:

- A. mechanical means while powered-off, and/or
- B. initializing an OpMode that pre-positions servos and motors to a desired stationary position. OpMode may control motors and servos to hold their position to maintain the STARTING CONFIGURATION.

ROBOTS holding STARTING CONFIGURATION during inspection or waiting for a MATCH to start may have to do so for several minutes and should limit the possibility of thermal failure (e.g., not having motors stalled against a hard stop).

Teams must also be especially cautious when operating a running ROBOT during inspection, notifying the INSPECTOR that the ROBOT is live and taking every precaution to ensure the process is carried out safely.

R103 ***There is no ROBOT weight limit.** There is no explicit weight limit for *FIRST* Tech Challenge ROBOTS.

While there is no official weight limit, teams should still consider the impact of a ROBOT'S weight on various factors, including but not limited to:

- FIELD TILE damage
- battery consumption
- ROBOT transportation
- total ROBOT performance

R104 **There is a horizontal expansion limit.** After the MATCH has started, ROBOTS may expand beyond the STARTING CONFIGURATION but are still subject to sizing constraints. The sizing constraints are:

- A. there is no vertical height limit relative to the TILE floor for ROBOT extensions,
- B. the horizontal size boundary is a 20 in. x 42 in. (50.8 cm x 106.7 cm) rectangle measured parallel (coplanar) to the TILE floor,
- C. the horizontal size boundary translates and rotates parallel (coplanar) to the TILE floor, with the CHASSIS of the ROBOT, which is the structural frame or base of a ROBOT that allows it to move and maneuver.
- D. the maximum extent of all extensions of the ROBOT must be confined to the horizontal size boundary, with the ROBOT chassis remaining in the same relative location within the horizontal size boundary at all times (the location and orientation of the chassis within the horizontal size boundary is determined by the team), and
- E. the horizontal size boundary as described in B is always parallel (coplanar) to the TILES, so ROBOTS which change orientation (drive, tip, roll, etc.) during the MATCH are still subject to the horizontal expansion limit measured parallel (coplanar) to the TILES.

This rule is intended to limit the amount of floor area each ROBOT can cover with the maximum range of motion of all extensions; extensions may be software or hardware limited. All possible movement of extensions outside the STARTING CONFIGURATION must be constrained within the horizontal size boundary.

Teams should be prepared to show compliance with this rule and demonstrate their ROBOT expansions during the inspection process. During inspection each ROBOT will be placed completely within a 20 in. x 42 in. taped box, with the position and orientation within the box chosen by the team. While keeping the ROBOT chassis stationary, the ROBOT must demonstrate that the full range of motion of all extensions outside of STARTING CONFIGURATION remain contained within the fixed 20 in. x 42 in. working area. This inspection verifies the ROBOT'S normal operating range, including software limits, as it would function during a typical MATCH. Additional software within the OpMode designed for emergency overrides, troubleshooting, or maintenance is acceptable and will not be evaluated as part of this compliance check.

Teams are subject to penalties listed in [G418](#) for any violations during the MATCH.

Please see the [R104 and R418 Recap Video](#) for helpful visuals to help teams comply with this rule.

Figure 12-1: Expansion Limits



OK

ROBOTS that demonstrate their full range of motion of all extensions and remain within the horizontal size boundary are OK

Example A

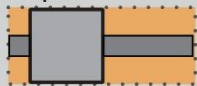

Example A has extensions on opposite sides of the CHASSIS. At full extension the ROBOT remains inside the boundary.

Example B

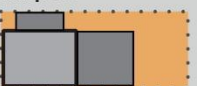

Example B has extensions on adjacent sides of the CHASSIS. At full extension the ROBOT remains inside the boundary.

Example C

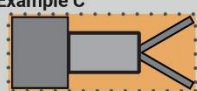

Example C has extensions on opposite sides which are wider than the CHASSIS. At full extension the ROBOT remains inside the boundary.

Example D

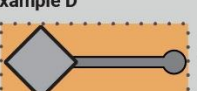

Example D has an extension which extends from a corner of the CHASSIS. At full extension the ROBOT remains inside the boundary.



NOT OK

ROBOTS that demonstrate their full range of motion of all extensions and extend beyond the horizontal size boundary are NOT OK

Example E



Example E has extensions on opposite sides of the CHASSIS. At full extension the ROBOT DOES NOT remain inside the boundary.

Example F

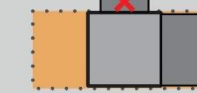

Example F has extensions on adjacent sides of the CHASSIS. At full extension the ROBOT DOES NOT remain inside the boundary.

Example G

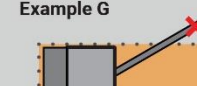

Example G has extensions wider than the CHASSIS. At full extension the ROBOT DOES NOT remain inside the boundary.

Example H

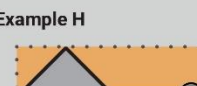

Example H has an extension which extends from a corner of the CHASSIS. At full extension the ROBOT DOES NOT remain inside the boundary.

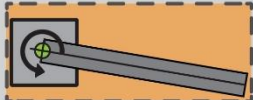
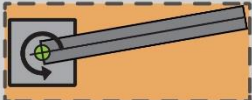
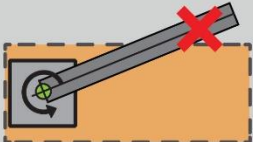

Figure 12-2: Expansion Limit Examples

CAUTION

ROBOTS with mechanisms that move relative to the CHASSIS should be careful to keep within the horizontal size boundary.



Example I - "Turret Mechanism"
ROBOTS with an arm on a pivot that rotates in the horizontal plane may violate this rule if the arm rotation extends the mechanism beyond the horizontal size boundary even if the overall size of the robot could still fit within a 42 x 20 in. box. ROBOTS with mechanisms capable of horizontal rotation should ensure rotation is restricted to remain inside the boundary defined during inspection at all times during MATCH play.

Position A	Position B	Position C
 <p style="font-size: 0.8em;">Team defined maximum travel in clockwise direction as viewed from top</p>	 <p style="font-size: 0.8em;">Team defined maximum travel in counter-clockwise direction as viewed from top</p>	 <p style="font-size: 0.8em;">ROBOT mechanism exceeds the team defined maximum allowable travel and extends outside the boundary. The boundary does not move with the mechanism therefore this would be a violation.</p>

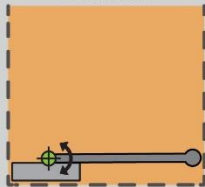
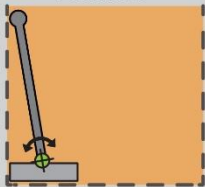
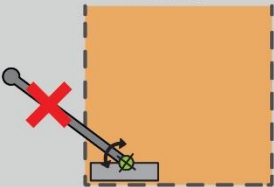
Example J - "Pivot Arm Mechanism"
ROBOTS with an arm on a pivot that rotates in the vertical plane may violate this rule if the arm rotation extends the mechanism beyond the horizontal size boundary even if the overall size of the robot could still fit within a 42 x 20 in. box. ROBOTS with mechanisms capable of vertical rotation should ensure rotation is restricted to remain inside the boundary defined during inspection at all times during MATCH play.

Position A	Position B	Position C
 <p style="font-size: 0.8em;">Team defined maximum travel in clockwise direction as viewed from side</p>	 <p style="font-size: 0.8em;">Team defined maximum travel in counter-clockwise direction as viewed from side</p>	 <p style="font-size: 0.8em;">ROBOT mechanism exceeds the team defined maximum allowable travel and extends outside the boundary. The boundary does not move with the mechanism therefore this would be a violation.</p>

Example K - "Sliding Extension Mechanism"
ROBOTS with linear extensions in the horizontal plane may violate this rule if the extension extends beyond the horizontal size boundary as it moves even if the overall size of the robot could still fit within a 42 x 20 in. box. ROBOTS with mechanisms capable of linear extension should ensure motion is restricted to remain inside the boundary defined during inspection at all times during MATCH play.

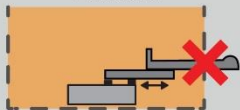
Position A	Position B	Position C
 <p style="font-size: 0.8em;">Team defined maximum travel in one direction as viewed from side</p>	 <p style="font-size: 0.8em;">Team defined maximum travel in opposite direction as viewed from side</p>	 <p style="font-size: 0.8em;">ROBOT mechanism exceeds the team defined maximum allowable travel and extends outside the boundary. The boundary does not move with the mechanism therefore this would be a violation.</p>



12.2 ROBOT Safety & Damage Prevention

R201 *Do not damage the TILE floor. Traction devices must not have surface features which could damage the TILE floor. Traction devices are all parts of the ROBOT that are designed to transmit any propulsive and/or braking forces between the ROBOT and the FIELD.

Examples of traction devices known to cause damage when used directly on TILE floors are high traction wheels (for example, AndyMark am-2256) and high grip tread (for example, Roughtop, AndyMark am-3309). While these (and other) COMPONENTS are not outright prohibited, e.g., used as part of an intake, MECHANISMS that involve these COMPONENTS contacting the TILE floor are not allowed.

R202 *No exposed sharp edges. Protrusions from the ROBOT and exposed surfaces on the ROBOT shall not pose hazards to the ARENA elements (including SCORING ELEMENTS) or people.

R203 *Design ROBOTS for safety. ROBOT parts shall not be made from hazardous materials, be unsafe, cause an unsafe condition, or interfere with the operations of other ROBOTS. Examples of items that will violate this rule include (but are not limited to):

- A. shields, curtains, or any other devices or materials solely designed or used to obstruct or limit the vision of any DRIVE TEAM members and/or interfere with their ability to safely control their ROBOT,
- B. speakers, sirens, air horns, or other audio devices that generate sound at a level sufficient to be a distraction,
- C. any devices or decorations specifically intended to jam or interfere with the remote sensing capabilities of another ROBOT, including vision systems, acoustic range finders, sonars, infrared proximity detectors, etc. This includes imagery on your ROBOT that utilizes or closely mimics 36h11 AprilTags,
- D. flammable gasses,
- E. any device intended to produce flames or pyrotechnics,
- F. hydraulic fluids or hydraulic items,
- G. switches or contacts containing liquid mercury,
- H. exposed, untreated hazardous materials (e.g., lead weights) used on the ROBOT. These materials may be permitted if painted, encapsulated, or otherwise sealed to prevent contact. These materials may not be machined in any way at an event.
- I. high intensity light sources used on the ROBOT may only be illuminated for a brief time while targeting and may need to be shrouded to prevent any exposure to participants. Complaints about the use of such light sources will be followed by re-inspection and possible disablement of the device,
- J. animal based materials,
- K. any device designed to damage or flip competing ROBOTS,
- L. devices or conditions that pose an unnecessary risk of entanglement
- M. materials that would cause an unsafe condition if released (loose ball bearings, coffee beans, etc.).

Flashing lights can be particularly distracting and can cause harm to some individuals. Decorative or functional lighting which flashes at greater than 2Hz will invite additional scrutiny and teams may be asked to disable or modify their lighting at the discretion of the Head REFEREE and/or LRI.

R204 ***SCORING ELEMENTS stay with the FIELD.** ROBOTS must allow removal of SCORING ELEMENTS from the ROBOT and the ROBOT from FIELD elements while powered off.

Teams must make sure that SCORING ELEMENTS and ROBOTS can be quickly, simply, and safely removed.

Teams are encouraged to consider [G501](#) when developing their ROBOTS.

R205 ***Do not contaminate the FIELD.** ROBOTS may not contain any materials which if unintentionally released would damage the FIELD, other ROBOTS or delay the start of a MATCH due to required decontamination. Lubricants may be used only to reduce friction within the ROBOT. Lubricants must not contaminate the FIELD or other ROBOTS.

Lubricants used on the ROBOT must not be excessively applied such that they spin off or drip off during normal ROBOT operations on the FIELD.

Additional examples of items that will violate this rule include (but are not limited to):

- any ballast not secured sufficiently, including loose ballast such as sand or ball bearings, such that it may be released on the FIELD during a MATCH
- liquid or gel materials
- tire sealant, and
- other lubricants

R206 ***Do not damage SCORING ELEMENTS.** ROBOT elements likely to contact SCORING ELEMENTS shall not pose a significant hazard to the SCORING ELEMENT.

SCORING ELEMENTS are expected to undergo a reasonable amount of wear and tear as they are handled by ROBOTS, such as scratching or marking. Gouging, tearing off pieces, or routinely marking SCORING ELEMENTS are violations of this rule.

R207 ***No air power on the ROBOT.** ROBOTS may not use any closed air devices such as but not limited to pneumatic solenoids or cylinders, gas storage vessels, gas springs, compressors, or vacuum generating devices. Air-filled (pneumatic) wheels are exempt from this rule.

12.3 Fabrication

R301 ***Legal COTS parts and raw materials can be modified.** Allowed raw materials and legal COTS parts can be modified (drilled, cut, painted, etc.) as long as no other rules are violated.

Raw materials refers to unfinished building stock such as but not limited to:

- sheet stock
- extruded shapes
- metals, plastic, rubber, and wood
- magnets

R302 ***Custom parts can be reused year to year.** FABRICATED ITEMS created before Kickoff are permitted.

R303 ***Custom designs and software can be reused year to year.** ROBOT software and designs created before Kickoff are permitted.

R304 ***SCORING ELEMENTS are not allowed for ROBOT construction.** Current season SCORING ELEMENTS or replicas of SCORING ELEMENTS are not allowed to be used as part of ROBOT construction or for any other team supplied SCORING ELEMENTS.

R305 ***During an event, work can occur outside of pit hours.** During an event a team is attending (regardless of whether the team is physically at the event location), the team may work on or practice with their ROBOT or ROBOT elements outside of the hours that pits are open.

For teams who chose to work offsite during an event please work smart and safely. Ensure team members get adequate rest and have sufficient adult supervision during afterhours and off-site work.

Note that [E107](#) and [E108](#) impose additional restrictions on work done on the ROBOT or ROBOT materials while attending an event.

R306 ***COTS MECHANISMS have limits.** COTS MAJOR MECHANISMS (as defined in [I301](#)) purposefully designed to complete a game task are prohibited.

Allowed exceptions to this rule are:

- A. COTS drive chassis, provided none of the individual parts violate any other rules.

COTS parts are intended to help teams design and build ROBOT MECHANISMS to complete game tasks and solve challenges but are not intended to be purpose-built complete bolt-on out-of-the-box solution to complete game objectives.

R307 ***COTS must be single DoF.** COTS COMPONENTS and MECHANISMS must not exceed a single degree of mechanical freedom (DoF). Examples of allowed COTS single degree of freedom MECHANISMS and COMPONENTS are as follows:

- A. linear slide kit,
- B. linear actuator kit,
- C. single speed (non-shifting) gearboxes,
- D. pulley,
- E. turntable,
- F. lead screw, and
- G. single DoF gripper.

Allowed exceptions to this rule are:

- H. ratcheting devices (wrenches, bearings, etc.),
- I. holonomic wheels (omni or mecanum),
- J. dead-wheel odometry kits,
- K. universal joints

The general test for a single degree of freedom MECHANISM is whether the orientation and position of each COMPONENT in the MECHANISM can be generally predicted based on the orientation and position of a single COMPONENT (such as the input) of the system.

Example 1: A mecanum drivetrain is made up of four independent drive modules, each with a single DoF (ignoring the DoF of the mecanum wheels as allowed by

this rule), attached to a common structure (e.g., chassis). The overall MECHANISM is still a single DoF.

Example 2: Dead wheel odometry modules, allowed by this rule, are typically composed of a 1 DoF wheel (ignoring the effect of the holonomic wheel) providing forward/backwards motion and a spring force providing an additional unique rotational or vertical motion, creating a two DoF system.

Example 3: Simple gripper claws, comprised of a single actuator moving two gripper jaws simultaneously or double actuators each controlling an independent gripper jaw, are by and large a single DoF. However, grippers that incorporate additional actuators providing additional twisting and/or bending actions (like a wrist) add degrees of freedom that are prohibited in COTS MECHANISMS.

12.4 ROBOT SIGN Rules

A ROBOT SIGN is a required assembly which attaches to the ROBOT. A ROBOT SIGN simultaneously identifies a ROBOT'S team number as well as its ALLIANCE affiliation for FIELD STAFF. Criteria used in writing these rules include the following:

- Maximize FIELD STAFF'S ability to determine team number and ALLIANCE of a ROBOT,
- Minimize the amount of design challenge in creating ROBOT SIGNS, and
- Increase consistency in displaying ROBOT identification.

R401 ***Two ROBOT SIGNS per ROBOT.** ROBOT SIGNS must be placed in at least two separate locations on the ROBOT. These locations must be on opposite or adjacent surfaces of the ROBOT, ≥ 90 degrees apart. All ROBOT surfaces visible to FIELD STAFF can be used for placing ROBOT SIGNS including the top of the ROBOT. The intent of this rule is for FIELD STAFF to easily view ROBOT SIGNS from at least 12 feet (3.66 meters) away before, during, and after the MATCH. ROBOT SIGNS must meet the following criteria:

- be made of a robust material,
- minimally be 6.5 inches (16.5 cm) wide)
- minimally be 2.5 inches (6.4 cm) tall (Figure 12-3) and
- be supported by the structure/frame of the ROBOT.

Examples of robust materials that satisfy this rule include, but are not limited to, acrylic, plastic laminated paper, wood, and metal. ROBOT SIGNS must be designed to withstand vigorous game play.

Figure 12-3: Team Number ROBOT SIGN Sizing

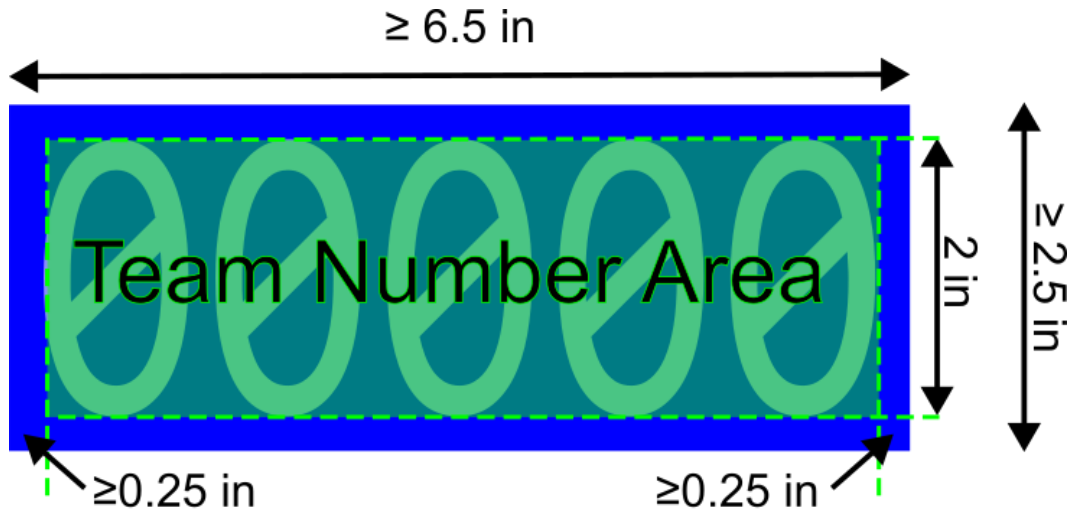

R402 *ROBOT SIGNS indicate your ALLIANCE. Each ROBOT SIGN must contain a 6.5 in. by 2.5 in. (16.5 cm by 6.4 cm) rectangle with a solid red or blue opaque background to indicate their ALLIANCE color (Figure 12-4), as assigned in the MATCH schedule at the event. Visible markings on ROBOT SIGNS when installed on the ROBOT, other than the following, are prohibited:

- those required per [R403](#)
- solid white FIRST logos no larger than 1.5 in. (3.8 cm) in height (Figure 12-5),
- small amounts of hook-and-loop tape, hard fasteners, or functional equivalents,
- narrow areas of differing colors exposed at corners, folds, or cutouts,
- dark narrow markings on background solely for template purposes,
- cannot be powered or rely on power from any sources to illuminate/reveal ALLIANCE color

ROBOT SIGNS that are reversible or configurable must not allow the opposite ALLIANCE color to be visible to FIELD STAFF, except where permitted by this rule.

Figure 12-4: Minimum sized ALLIANCE rectangle

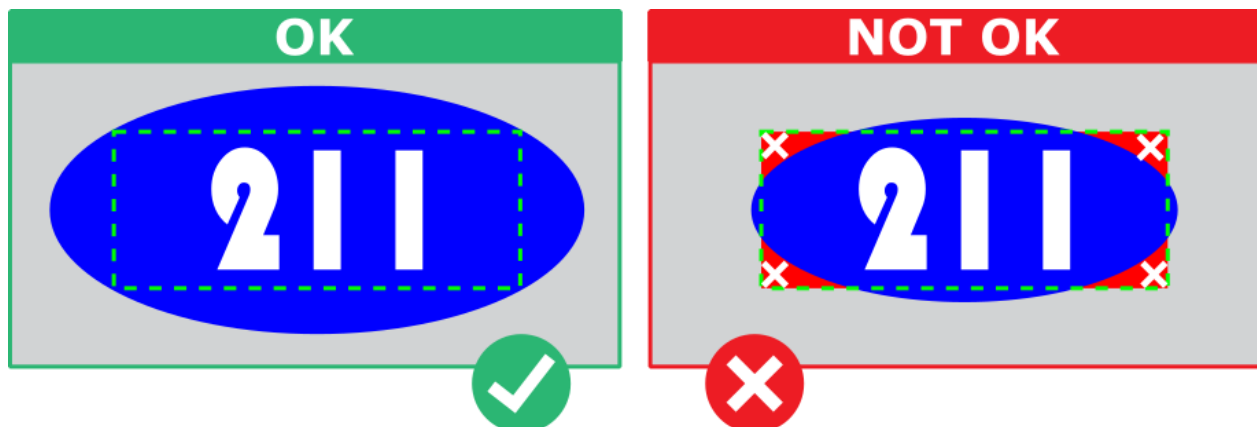

Figure 12-5: Legal team number display for team 117 playing on the red ALLIANCE



R403 *Team number on ROBOT SIGNS, Team numbers must be displayed and positioned on the ROBOT SIGN as shown in Figure 12-3, Figure 12-6, and Figure 12-7 and meet the following additional criteria:

- A. consist of solid opaque white Arabic numbers (e.g., 1,2,3,4) nominally 2 inches (5.1 cm) tall,
- B. there must be a minimum of 1/4" inches (6.4 mm) of background surrounding the numbers,
- C. numbers may not be vertically stacked (Figure 12-7)
- D. be made of robust materials
- E. cannot be powered or rely on power from any sources to illuminate/reveal numbers

Figure 12-6: Legal number for team 21001 playing on the blue ALLIANCE



Figure 12-7: Team number orientation examples for team 1355 playing on the blue ALLIANCE



If a team at an event does not have completely legal ROBOT SIGNS, and there is no color printer or other means available at the event to create a legal ROBOT SIGN, the Head REFEREE may approve an alternate substitute for use at the event.

Nominal measurements for team numbers provide for a tolerance of +/- ¼" to the number height to allow for purchased numbers that are nominally 2" tall.

Team numbers must be robust enough to withstand the rigors of MATCH play. Example robust materials include:

- self-adhesive numbers (mailbox or vinyl numbers)
- ink jet or laser printed numbers on paper and laminated or protected from ROBOT-to-ROBOT interaction.

Examples of prohibited team numbers on ROBOT SIGNS include but are not limited to:

- team numbers only visible by edge lit engraved plastic
- LED Display numbers

12.5 Motors & Actuators

R501 *Allowable motors. The only allowed motor actuators are:

Table 12-1: Motor allowances

Motor Name	Part Numbers Available	Notes
AndyMark NeveRest 12V DC	am-3104, am-3104b	
AndyMark NeveRest Hex 12V DC	am-3104c	
goBILDA Yellow Jacket 520x Series 12V DC	5201-0002-0026, etc.	5201, 5202, 5203, and 5204 series
Modern Robotics / MATRIX 12V DC	5000-0002-0001	
REV Robotics HD Hex 12V DC	REV-41-1291	
REV Robotics Core Hex 12V DC	REV-41-1300	
Studica Robotics Maverick 12V DC	75001	
TETRIX MAX 12V DC	739530, 39530	Discontinued
TETRIX MAX TorqueNADO 12V DC	W44260	
VEX EDR 393	276-2177	Counts as a servo for R503
Factory installed vibration and autofocus motors resident in COTS computing devices (e.g., rumble motor in a smartphone); can only be used as part of the device and cannot be removed and/or repurposed. These motors do not count toward the limit in R503.		
Motors integral to a COTS sensor (e.g., LIDAR, scanning sonar), provided the device is not modified except to facilitate mounting. These motors do not count toward the limit in R503.		

Many legal gearmotors are sold with labeling based on the entire assembly. These motors may be used with or without the provided gearbox.

R502 ***Allowable servos.** Servo actuators must meet the requirements below. Servos must be compatible with the power regulation devices they are ultimately used with (per [R505](#)) and may include additional servo position output interfaces (e.g., 4th Wire Position Feedback).

Table 12-2: Servo Requirements at 6V

Actuator Class	Mechanical Output Power	Stall Current	Example Servos (including, but not limited to) NOT COMPLETE LIST
Servo	≤ 8 watts @6V	≤ 4 amps @6V	AndyMark High-Torque Servos (am-4954)
			Axon MAX+ Servo (Axon MAX+)
			DSSERVO 35KG Coreless (DS3235MG)
			FEETECH Digital Servo (FT5335M-FB)
			goBILDA Dual Mode Servo (2000-0025-0003)
			REV Robotics Smart Servo (REV-41-1097)
Linear Servo	N/A	≤ 1 amps @6V	Studica Multi-Mode Smart Servo (75002)
			Actuonix Micro Linear Servo (P8-100-252-12-R)
			Hitec Linear Servo (HLS12-3050-6V)
			Studica Linear Servo RC Actuator (75014)

[Servo mechanical output power](#) is approximated by the following formula (using 6V data reported by manufacturer):

- Mechanical Output Power = 0.25 x (Stall Torque in N-m) x (No Load Speed in rad/s)**

Servos must meet both requirements to be legal for use. Refer to the [Inspection Quick Reference](#) document for a list of servos that are pre-approved, otherwise teams must be able to provide documentation verifying servo specifications. Use the [online calculator](#) to verify output power compliance.

If a manufacturer does not provide 6V specs, any specs for voltages that exceed 6V are allowed to be used.

Stall current is the maximum stall current possible for the device at the specified voltage, regardless of any user or VENDOR adjustable software limits that may be available within the servo.

It is important to ensure the voltage provided by the intended power regulation device is within the operating voltage range of the desired servo. The REV Control Hub and REV Expansion Hub provide 5V to servos, and the REV Servo Power Module, Studica Servo Power Block, and REV Servo Hub provide 6V to servos. While virtually all servos are compatible with 6V, servos with an operating voltage range of 6-8.4 DCV, for example, may not work properly when only provided 5V.

R503 ***ROBOTS are limited to a total of 8 motors and 12 servos.** A ROBOT may not have more than 8 motors and 12 servos from the allowable actuator lists per [R501](#) and [R502](#) for all MECHANISMS used in all configurations, with the following exceptions:

- A. The VEX EDR 393 (276-2177) motor is counted as a servo instead of a motor.

If a ROBOT has multiple configurations used at a single event which use different MECHANISMS, the sum total of all motors and servos must be less than or equal to the limit set in this rule.

For servos, note that each REV Expansion Hub and REV Control Hub provide 5V and are limited to a max current output of 5A total shared across all servo ports and the +5V auxiliary power port, with a 2A maximum limit across paired servo ports (10W of maximum electrical output power per port pair, 25W total). Teams should make sure that their total servo power usage always remains below this limit.

Given the extensive number of motors and servos allowed on the ROBOT, teams are encouraged to consider the total power available from the ROBOT battery during the design and build of the ROBOT. Drawing large amounts of current from many motors and/or servos at the same time could lead to drops in ROBOT battery voltage that may result in exceeding the battery fuse limits or browning out the control system leading to power loss or communications loss.

R504 ***Do not modify actuators unless explicitly allowed.** The integral mechanical and electrical system of any motor or servo must not be modified. Motors and servos used on the ROBOT shall not be modified in any way, except as follows:

- A. the mounting brackets and/or output shaft/interface may be modified to facilitate the physical connection of the motor to the ROBOT and actuated part,
- B. the electrical leads may be trimmed to length as necessary and connectors or splices to additional wiring may be added (per [R503](#)), and purely electrical enclosures can be substituted with functionally equivalent replacements,
- C. servos may be modified as specified by the manufacturer (e.g., re-programming or modification for continuous rotation),
- D. minimal labeling may be applied to indicate device purpose, connectivity, functional performance, etc. as long as the team applied label does not obstruct the markings used to identify the device,
- E. insulation may be applied to electrical terminals,
- F. repairs, provided the original performance and specifications are unchanged, and
- G. maintenance recommended by the manufacturer.

R505 ***All actuators must be powered from approved devices.** With the exception of servos, fans, or motors integral to sensors of COTS computing devices permitted in [R501](#), each actuator must be controlled by a power regulating device. The only power regulating devices for actuators permitted on the ROBOT are:

Table 12-3: Power Regulators and Limits

Power Regulating Device	Part Number	Load Limit per Device
REV Control Hub or Expansion Hub Motor Ports	REV-31-1153 / REV-31-1595	2 Motors per Port
REV Control Hub or Expansion Hub Servo Ports	REV-31-1153 / REV-31-1595	2 Servos per Port
REV Servo Power Module	REV-11-1144	2 Servos per Port OR 2 VEX Motor Controller 29 (one per port)
REV Robotics Servo Hub	REV-11-1855	2 Servos per Port
REV SPARKmini	REV-31-1230	2 Motors per Device
Studica Servo Power Block	75005	2 Servos per Port
VEX Motor Controller 29	276-2193	1 VEX EDR 323 Motor (Counts as a Servo per R503)

R506 ***No relays or alternative electrical actuation.** The application of electromechanical actuation through the use of additional relays, electromagnets, electrical solenoid actuators, or related systems is prohibited. In addition, the use of relays and electromagnets is also prohibited.

12.6 Power Distribution

In order to maintain safety, the rules in this section apply at all times while at the event, not just while the ROBOT is on the FIELD for MATCHES.

R601 ***Battery limit – everyone has the same main ROBOT power.** The only legal source of electrical energy for the ROBOT control system and actuation during the competition, the ROBOT battery, must be 1 and only 1 approved 12V NiMH main battery. The ROBOT main battery must have a COTS equivalent in-line 20A ATM mini blade fuse installed. Installed connectors may be replaced with other popular connectors such as Anderson Powerpole, XT30, or any connector with a comparable power rating. The only allowed ROBOT main power battery packs are:

Table 12-4: Legal ROBOT Main Power Battery Packs

Battery Pack	Part Number	Notes
AndyMark Flat Pack Battery DC 12V	am-5290	
goBILDA 12V NiMH Nested Battery	3100-0012-0020	
Matrix 12V 3000mAh NiMH	14-0014	
REV 12V Slim Battery	REV-31-1302	
Studica 12V 3000mAh NiMH	70025	
TETRIX MAX 12V 3000mAh NiMH	W39057	Formerly 739023

There are many other similar style batteries available from multiple VENDORS, but only the listed manufactures and part numbers are legal for use at FIRST Tech Challenge Events.

Batteries should be charged in accordance with manufacturer's specification.
(Please see the [FIRST Safety Manual](#) for additional information.)

R602 ***Other batteries are only allowed for peripheral devices and LEDs only.** COTS USB battery packs with a capacity of 100Wh or less (27,000mAh at 3.7V), with 5V/5A max output or 12V/5A max output using USB-PD per port, and batteries integral to a self-contained camera (e.g., GoPro style camera) may be used provided they are:

- A. connected only using unmodified COTS cables,
- B. charged according to manufacturer recommendations,
- C. securely fastened to the ROBOT,
- D. not supplement power to any of the ROBOT actuators, and
- E. not used by any devices receiving control signals from the ROBOT control system (i.e., COTS USB battery packs must remain electrically isolated from the ROBOT power systems.)

Exceptions to part E of this rule are:

- i. powered USB Hubs, and
- ii. ROBOT CONTROLLER smartphones

For example, a REV Blinkin powered by a COTS USB battery pack cannot be controlled by signals from a REV Control or Expansion Hub. Any device receiving signals from a REV Control or Expansion Hub must be powered by the main ROBOT battery.

R603 ***Charge batteries with safe connectors.** Any battery charger used to charge a ROBOT battery must have a corresponding polarized connector installed.

Batteries must never be charged using alligator clips or similar.

R604 ***Charge batteries at a safe rate.** Any battery charger used to charge a ROBOT battery may not be used such that it exceeds a 3-amp average charge current. Follow all manufacturer recommendations when charging batteries.

R605 ***Batteries are not ballast.** No batteries other than those allowed per [R601](#) and [R602](#) are allowed on the ROBOT, whether or not they are being used to supply power.

For example, teams may not use additional batteries as extra weight on their ROBOTS.

R606 ***Batteries should be securely mounted.** The ROBOT battery must be secured such that it will not dislodge during vigorous ROBOT interaction including if the ROBOT is turned over or placed in any arbitrary orientation. Batteries must be mounted such that they are protected from direct contact with other ROBOTS or any sharp edges.

R607 ***Electrical connections should be robust and must be insulated.** All electrical paths may include intermediate elements such as COTS connectors (Anderson Powerpole, XT30, and similar crimp or quick-connect style connectors), splices, COTS flexible/rolling/sliding contacts, and COTS slip rings, as long as the entire electrical pathway is via appropriately gauged/rated elements and all connections are protected from accidental electrical shorts

Teams are strongly encouraged to insulate all exposed electrical terminations or provide physical barricades to protect from accidental electrical shorts.

- R608** *Limit non-battery energy. Non-electrical sources of energy used by the ROBOT (i.e., stored at the start of a MATCH) shall come only from the following sources:
- A. a change in the altitude of the ROBOT center of gravity, or
 - B. storage achieved by deformation of ROBOT parts including, but not limited to, springs, rubber bands, surgical tubing, etc.

- R609** *Connect the ROBOT battery safely though the Main Power Switch. Exactly one main power switch must control all power provided by the ROBOT battery pack to all power regulating devices on the ROBOT such that all the following conditions are met:

- A. must be one of the following approved power switches:

Table 12-5: Legal Power Switches

Power Switch	Part Number
AndyMark FTC Power Switch w/ Bracket	am-4969
REV Switch Cable and Bracket	REV-31-1387
Studica On/Off Power Switch Kit	70182
TETRIX R/C Switch Kit	W39129

- B. must be mounted or located where it is accessible to the team and FIELD STAFF
- C. a [“Main Power Switch” label](#) no smaller than 1 in. x 2.5 in. (2.5 cm x 6.4 cm) must be placed near the switch on a flat surface.

Figure 12-8: example Main Power Switch label



- D. secondary power switches can be used on the 12V line downstream of the main power switch provided they are clearly labeled as “secondary switch” and must still be one of the approved switches.

There are no specific location requirements for the main power switch, but it should be located clear of any moving parts and other obstructions that would block its access during normal ROBOT operations.

Examples considered not “quickly and safely accessible” include main power switches covered by an access panel or door, or mounted on, underneath or immediately adjacent to moving COMPONENTS.

The main power switch should be mounted on the ROBOT, so it is protected from ROBOT-to-ROBOT contact to avoid inadvertent actuation or damage.

- R610** *Fuse ratings should not be altered. Fuses must not be replaced with fuses of higher rating than originally installed or according to manufacturer's specifications; fuses may not be shorted out. Fuses must not exceed the rating of those closer to the battery. If necessary, a fuse may be replaced with a

smaller rating. Replaceable fuses must be single use only; self-resetting fuses (breakers) are not allowed.

R611 *The ROBOT frame is not a wire. All wiring and electrical devices shall be electrically isolated from the ROBOT frame. The ROBOT frame must not be used to carry electrical current. Electrically grounding the control system electronics to the frame of the ROBOT is only permitted such that all of the following conditions are met:

A. must use one of the following approved parts:

Table 12-6: Legal ROBOT Grounding Straps

Grounding Strap	Part Number
AndyMark Resistive Grounding Strap	am-4648a
REV Resistive Grounding Strap	REV-31-1269
Swyft Grounding Cable	SR-Ground-01

- B. the strap/cable must directly connect to a fully COTS COMPONENT with an XT30 connector, and also must connect directly to the frame of the ROBOT (via the resistive terminal).
- C. no ROBOT COMPONENTS or MECHANISMS are designed to electrically ground the ROBOT frame to the FIELD.

Compliance with this rule can be checked by unplugging the battery from the ROBOT main power switch assembly and observing a $>120\Omega$ resistance between the (+ / red) input terminal of the ROBOT main power switch assembly in the "ON" position or the (- / black) input terminal of the ROBOT main power switch assembly and any electrically connected point on the ROBOT. Most aluminum has a clear anodizing layer or oxidation layer on it that acts as an insulator. In order to make a good electrical connection with the grounding strap to the frame, it may be necessary to scratch/file/remove the anodize/oxidation layer from the area of contact with the metal first.

Note that some cameras, decorative lights, and sensors (some encoders, some IR sensors, etc.) have grounded enclosures or are manufactured with conductive plastics. These devices must be electrically isolated from the ROBOT frame to ensure compliance with this rule.

Examples of devices with COTS XT30 connectors include but are not limited to the REV Control Hub (REV-31-1595), a COTS XT30 power distribution block (such as a REV-31-1293), or a COTS Anderson Powerpole to XT30 Adapter (such as REV-31-1385). For additional details on installation of the grounding strap, please see the [ROBOT Wiring Guide](#).

R612 *Electrical system must be inspectable. All power regulating devices (per [R505](#)), associated wiring, and all fuses must be visible for inspection.

"Visible for inspection" does not require that the items be visible when the ROBOT is in STARTING CONFIGURATION, provided the team can make the items viewable during the inspection process.

- R613** ***No high voltage allowed.** Any active electrical item that is not an actuator (specified in [R501](#)) or power regulation device (specified in [R505](#)) is considered a CUSTOM CIRCUIT. CUSTOM CIRCUITS shall not provide regulated output voltages exceeding 5V but may pass through unregulated battery voltage.
- R614** ***Energize Power Regulating Devices as specified.** All power regulating devices ([R505](#)) must be powered per the manufacturer’s instructions and the following table must be true:

Table 12-7: Power Regulation Device Power Requirements

Power Regulating Device	Part Number	Method of Powering
REV Control Hub / REV Expansion Hub	REV-31-1153 / REV-31-1595	Only powered using the XT30 connectors on the device by the ROBOT main battery
REV Servo Power Module	REV-11-1144	Only powered using the screw terminals and must only be powered by the ROBOT main battery
REV Robotics Servo Hub	REV-11-1855	Only powered using the power terminals and must only be powered by the ROBOT main battery
REV SPARKmini	REV-31-1230	Only powered by the Power input and must only be powered by the ROBOT main battery
Studica Servo Power Block	75005	Only powered by JST-VH power connector, and must only be powered by the ROBOT main battery
VEX Motor Controller 29	276-2193	Only powered via servo connector

- R615** ***Use appropriately sized wire.** All circuits shall be wired with appropriately sized insulated copper wire (SIGNAL LEVEL cables do not have to be copper):

Table 12-8: Wire sizing requirements

Application	Minimum Wire Size
12V Main Battery Power	18 AWG (19 SWG or 1 mm ²)
Motor Power (unless otherwise listed)	
11-20A fuse protected circuit	
Motor Power - TETRIX MAX 12V DC Motors, REV Robotics Core Hex (REV-14-1300)	22 AWG (22 SWG or 0.5 mm ²)
PWM / Servo	
LEDs (5V / 12V)	
≤10A fuse protected circuit	
SIGNAL LEVEL circuits (i.e., circuits which draw ≤1A continuous and have a source incapable of delivering >1A, including but not limited to: I2C, DIO, Analog, encoder and RS485 connections)	28 AWG (29 SWG or .08 mm ²)

Integrated wires originally attached to legal COTS devices or wires included/sold by the manufacturer are considered part of the device and by default legal. Such wires are exempt from this rule.

In order to show compliance with these rules, teams should use wire with clearly labeled sizes if possible. If unlabeled wiring is used, teams should be prepared to demonstrate that the wire used meets the requirements of this rule (e.g., wire samples and evidence that they are the required size).

- R616** ***Use specified wire colors.** All non-SIGNAL LEVEL wiring with a constant polarity (i.e., except for outputs of motor controllers, or sensors) must use consistent color-coding with different colors used for the positive (red, yellow, white, brown, or black with white stripe) and negative/common (black, blue) wires. Integrated wires originally attached to legal COTS devices or wires included/sold by the manufacturer are considered part of the device and by default legal. Such wires are exempt from this rule.
- R617** ***Powered USB hubs must draw energy from approved sources.** Powered USB hubs used on the ROBOT can only be powered through one of the following ways:
- an approved COTS USB battery Pack per [R602](#), or
 - the 5V auxiliary power port on the REV Expansion Hub or REV Control Hub
- R618** ***Do not modify critical power paths.** CUSTOM CIRCUITS shall not directly alter the power or control pathways between:
- the ROBOT battery and main power switch,
 - the main power switch and a power regulating device (per [R609](#)),
 - any two power regulating devices (per [R613](#)), or
 - power regulating devices and actuators.

Custom high impedance voltage monitoring or low impedance current monitoring circuitry connected to the ROBOT'S electrical system is acceptable if the effect on power pathways is inconsequential.

Altering a power pathway includes, but is not limited to, altering the voltage of the power pathway using a boost (DC voltage step-up) or buck (DC voltage step-down) converter or otherwise altering the natural variable DC voltage provided by the ROBOT battery to create a constant DC voltage.

Devices that modify actuator control signals or power (except those allowed by [R505](#)) are prohibited, such as the goBILDA Servo Travel Tuner.

- R619** ***Do not mix and match power on or between power regulation devices.** The following rules must be adhered to when using power on any power regulation device (per [R505](#)):
- other than power used to energize the power regulation device (per [R614](#)) no power originating outside the power regulation device may be used on or with devices connected to the power regulation device. The only exceptions are connections intended for communication between devices (RS485/USB/PWM/etc.).

Example 1: The +5V port on a REV Expansion Hub cannot be used to power devices connected to a REV Control Hub's I2C ports.

Example 2: A regulated 5V output provided by a CUSTOM CIRCUIT cannot be used to power an I2C device connected to a REV Control Hub.

- B. power originating from ports/connectors on power regulation devices may only be used for devices directly connected to that port/connector. The only exception to this is +5V power from the +5V power port on the REV Control Hub or REV Expansion Hub may be used in conjunction with any Analog, Digital, or I2C port on that device. In addition, the +5V power port may be used to power external devices.

Example 1: The power provided by Digital Port 0-1 on a REV Control Hub should not be used to power devices connected to I2C Port 0. However, power provided by Digital Port 0-1 can be used to power devices connected to both signal channels N and N+1 on Digital Port 0-1.

Example 2: The +5V power can be used to power external devices such as externally powered USB hubs (per R617).

- C. 6V power provided by the REV Servo Power Module, REV Robotics Servo Hub, or Studica Servo Power Block may only be used for powering servos.

6V power provided by the REV Servo Power Module, REV Robotics Servo Hub, or Studica Servo Power Block may only be used for powering servos.

12.7 Control, Command & Signals System

R701 ***Control the ROBOT with a single ROBOT CONTROLLER.** ROBOTS must be controlled via 1 programmable ROBOT CONTROLLER. The ROBOT CONTROLLER is the only source of control for the ROBOT actuators and must be comprised of:

- A. REV Control Hub (REV-31-1595), or
- B. an allowed smartphone Android device connected to a REV Expansion Hub (REV-31-1153)

In addition to A or B, a ROBOT may also contain:

- C. no more than one additional REV Expansion Hub (REV-31-1153)

R702 ***Teams may not alter coprocessor software.** Modifying software on coprocessors, unless explicitly permitted in this rule or rule [R703](#), is not allowed by teams. Firmware updates in binary form provided by the manufacturer may be applied as directed by the manufacturer.

The following are examples of allowed devices:

Example 1: The Adafruit BNO055 Absolute Orientation Sensor is an IMU package with an onboard ARM Cortex-M0 based coprocessor to crunch sensor data and produce composite output. Its coprocessor contains software that is not intended by the manufacturer to be modified by users.

Example 2: The SparkFun Optical Tracking Odometry Sensor is a laser and IMU tracking device that uses an onboard microcontroller to perform complex calculations and produce simplified results. SparkFun does provide the source code and toolchain for advanced users to modify/update the software, which is not permitted by this rule. Firmware updates provided by SparkFun are allowed to be applied to the device.

Example 3: The Digital Chicken Labs OctoQuad FTC Edition is an 8-channel encoder/PWM interface, utilizing a Raspberry Pi Pico coprocessor. Teams are

not permitted to modify software running on the device, including replacing the software with their own. Updates provided in binary form by the manufacturer (Digital Chicken Labs) may be applied to the device.

R703 ***Some vision coprocessors can be programmed.** Programmable vision coprocessors that are natively supported by the FTC SDK may be programmed. The programmable vision coprocessors that are supported are:

Table 12-9: Supported programmable vision coprocessors

Device	Part Number
Limelight Vision Limelight 3A	LL_3A

Example 1: Optical Flow sensors are an example of a sensor that utilizes a vision coprocessor that is treated no differently than other coprocessors per [R702](#).

Example 2: The DFRobot HuskyLens and the Charmed Labs Pixy2 are examples of vision coprocessors that are configurable but not programmable and are treated no differently than other coprocessors per [R702](#).

Example 3: The OpenMV Cam, Luxonis OAK-1, and LimeLight Vision Limelight 3G are examples of programmable vision coprocessors that are prohibited.

See [R715](#) for more information regarding vision coprocessor support.

R704 ***Use only legal Android smartphone devices.** Android smartphone devices, if used, must minimally be running the Android 7 (Nougat) operating system. The following table lists the legal Android smartphones:

Table 12-10: Legal Android Smartphones

Phone	Notes
Motorola Moto G4 Play	Sometimes noted as “4th Generation”
Motorola Moto G5	
Motorola Moto G5 Plus	
Motorola Moto E4	USA versions only, includes SKUs XT1765, XT1765PP, XT1766, and XT1767
Motorola Moto E5	XT1920
Motorola Moto E5 Play	XT1921

Some supported models still using Android 6.x (Marshmallow) might be updatable by the [Motorola Rescue and Smart Assistance Tool](#).

Teams outside North America with extenuating circumstances (such as international purchasing limitations) are allowed to use alternate Android smartphones if necessary. Teams doing so are required to fill out [this alternate Android Smartphone survey](#).

- R705** ***Smartphone android devices used as a ROBOT CONTROLLER must connect to the REV Expansion Hub using USB.** If used as a ROBOT CONTROLLER, the smartphone android device must be connected via its integrated micro-USB port to a REV Expansion Hub either:
- A. a mini-USB to OTG Micro Cable, or
 - B. any combination of Mini USB Cable, a USB Hub (powered or unpowered) and an OTG Micro adaptor (the hub can be integrated into the USB Hub).
- R706** ***Bandwidth is restricted.** While in the ARENA and MATCH queue devices on the ROBOT network are limited to only the ROBOT CONTROLLER device and the DRIVER STATION device, and communication between the ROBOT CONTROLLER and the DRIVER STATION device is limited to ROBOT command data from the DRIVER STATION app, debugging data and telemetry from the ROBOT CONTROLLER app to the DRIVER STATION app, and single frame images used during ROBOT set-up pre-MATCH. When not in the ARENA or MATCH queue, additional devices (including, but not limited to, programming computers) may also communicate on the ROBOT network and teams must be careful to limit Wi-Fi streaming bandwidth between devices.
- R707** ***Configure devices for your team number.** The ROBOT CONTROLLER, DRIVER STATION, and any spares used must be configured/named to correspond to the correct team number as follows:
- A. ROBOT CONTROLLER should be named <team number>-RC (e.g., 12345-RC)
 - B. DRIVER STATION should be named <team number>-DS (e.g., 12345-DS)
 - C. If a spare ROBOT CONTROLLER or DRIVER STATION is configured, a letter designator may be added <team number>-<letter>-RC/DS (e.g., 12345-A-DS, 12345-B-DS)

See the [DRIVER STATION Instructions](#) and [ROBOT CONTROLLER Instructions](#) for a detailed procedure for updating DRIVER STATION and ROBOT CONTROLLER “names.”

- R708** ***Do not interfere with the ROBOT networks.** During a MATCH, all communications signals must originate from only the ROBOT CONTROLLER device or the DRIVER STATION device using the ROBOT CONTROLLER Wi-Fi network. No other devices may attempt to connect to, interfere with, or alter the ROBOT CONTROLLER Wi-Fi network.

Teams are allowed to connect programming laptops and other devices to the ROBOT CONTROLLER Wi-Fi network outside of a MATCH. These devices must be disconnected from the ROBOT CONTROLLER Wi-Fi network prior to and during a MATCH.

- R709** ***No other wireless allowed.** No form of wireless communication shall be used to communicate to, from, or within the ROBOT, except those specified per [R706](#) and [R708](#).

Devices that employ signals in the visual spectrum (e.g., cameras) and non-RF sensors that do not receive human-originated commands (e.g., “beam break” sensors or IR sensors on the ROBOT used to detect FIELD elements) are not wireless communication devices and thus this rule does not apply.

- R710** ***Use assigned Wi-Fi bands and/or channels if requested.** Teams may be asked by the Event Director to use a specific Wi-Fi frequency band or channel on the day of competition. If requested, teams are required to do so. Teams may work with the FTA or wireless technical advisor (WTA) to find an alternate frequency band or channel if the suggested band/channel is deemed problematic by the FTA or WTA.

R711 ***ROBOT CONTROLLER must be visible for inspection.** The ROBOT CONTROLLER device must be mounted on the ROBOT such that the diagnostic lights, or device screen if applicable, can be visible for inspection.

“Visible for inspection” does not require that the items be visible when the ROBOT is in STARTING CONFIGURATION or normally during a MATCH, provided the team can make the items viewable during the inspection process if necessary.

Teams are strongly encouraged to make the diagnostic lights visible during normal MATCH play ROBOT configurations. If diagnostic LEDs are not visible during a MATCH, FIELD STAFF may not be able to provide comprehensive support to the team.

Teams are encouraged to mount the ROBOT CONTROLLER device away from noise generating devices such as motors and EMF shielding materials like sheets of metal.

R712 ***Only specified modifications to core control system devices permitted.** The DRIVER STATION device and software, Android-based ROBOT CONTROLLER device, main and secondary power switch(es), power regulation devices, fuses, and batteries shall not be tampered with, modified, or adjusted in any way (tampering includes drilling, cutting, machining, rewiring, disassembling, painting, removing enclosures and replacing with custom enclosures, etc.), with the following exceptions:

- A. wires, cables, and signal lines may be connected via the standard connection points provided on the devices,
- B. fasteners (including adhesives) may be used to attach devices to the OPERATOR CONSOLE or ROBOT or to secure cables to the device,
- C. thermal interface material may be used to improve heat conduction,
- D. labeling may be applied to indicate device identification, purpose, connectivity, functional performance, etc. as long as they do not cover labels or markings used to identify the product,
- E. jumpers may be changed from their default location,
- F. jumpers or switches may be moved to configure devices per the manufacturer’s manual,
- G. device firmware may be updated with manufacturer supplied firmware,
- H. integral wires on motor controllers and batteries may be cut, stripped, and/or connectorized,
- I. devices may be repaired, provided the performance and specifications of the device after the repair are identical to those before the repair,
- J. add insulating material to exposed conductors,
- K. tape may be applied for debris protection, and
- L. Power switch mounting brackets can be modified or replaced

Please note that while repairs are permitted, the allowance is independent of any manufacturer’s warranty. Teams make repairs at their own risk and should assume that any warranty or return options are forfeited. Repairs must be functionally equivalent to original device condition.

Be aware that diagnosing and repairing COMPONENTS such as these can be difficult.

For example, “repairs” that change connector types, include device footprint modifications, or provide mechanical enhancements, are prohibited.

R713 ***Always keep control system device software up to date.** The following table lists the recommended software versions for each core control electronics module, and a link on how to update this software. Note that some devices have multiple pieces of software that may need to be updated each season, and not all software is available prior to kickoff each season. Check the [FIRST Tech Challenge Blog](#) for release announcements.

Regardless of the versions selected, it is highly recommended that the installed ROBOT CONTROLLER App and DRIVER STATION App versions match major and minor values to ensure compatibility as not all software versions are compatible with each other.

Table 12-11: Recommended Software for Control System Devices

Device	Software and Minimum Recommended Versions	How to Update
REV Control Hub (REV-31-1595)	Control Hub OS Recommended: 1.1.2	Updating the Control Hub OS
REV Control Hub (REV-31-1595)	Hub Firmware Recommended: 1.8.2	Updating the Hub Firmware
REV Control Hub (REV-31-1595)	ROBOT CONTROLLER App Recommended: 10.0	Updating the ROBOT CONTROLLER App
REV Expansion Hub (REV-31-1153)	Hub Firmware Recommended: 1.8.2	Updating the Hub Firmware
Android Smartphone (ROBOT CONTROLLER device)	ROBOT CONTROLLER App Recommended: 10.0	Updating the ROBOT CONTROLLER App
Android Smartphone (DRIVER STATION device)	DRIVER STATION App Recommended: 10.0	Updating the DRIVER STATION App
REV Driver Hub (REV-31-1596)	Driver Hub OS Recommended: 1.2.0	Updating the Driver Hub OS
REV Driver Hub (REV-31-1596)	DRIVER STATION App Recommended: 10.0	Updating the DRIVER STATION App
REV Servo Hub (REV-11-1855)	REV Servo Hub Firmware Recommended: N/A	N/A

Software at or above the recommended versions have the latest bugfixes and updates. Teams are highly encouraged to update their software minimally to the recommended version. FIELD STAFF will not be able to provide comprehensive support to teams with software older than the recommended version.

Teams may choose to run older versions without affecting their ROBOT inspection status.

R714 ***USB is for vision.** Only the following devices may be connected to the ROBOT control system using USB:

- A. webcams and optical vision sensors per [R715](#),
- B. USB hub, and
- C. a REV Expansion Hub

R715 *Use only supported USB vision. Only single image sensor vision devices that are natively supported by the ROBOT CONTROLLER app are allowed to connect to USB (stereoscopic cameras are not allowed). This includes the following:

- A. all UVC compatible USB webcams (Logitech C270, and related), and
- B. Vision coprocessors allowed per [R703](#).

To request support (or to provide sample drivers) for alternate USB vision devices for inclusion in future *FIRST* Tech Challenge seasons, please use the [Part Suggestion Form](#).

UVC compatible USB webcams may only use the UVC provided stream / data. No other interfaces or data provided by the webcam may be used.

R716 *Recording devices are okay. Self-contained video recording devices (GoPro or similar) are allowed providing they are used only for non-functional post-MATCH viewing and the wireless capability is turned off.

R717 *Lasers must be safe. Lasers are not allowed unless they meet all of the following criteria:

- A. must be part of a sensor,
- B. must be rated as IEC/EN 60825-1 "Class I" or IEC/EN 62471 "Exempt," and
- C. non-visible spectrum

R718 *Configure Android devices appropriately. ROBOT CONTROLLER and DRIVER STATION Android devices (smartphones, REV Control Hub, REV Driver Hub) must additionally be configured in the following ways:

- A. REV Control Hub users must [change the Wi-Fi password](#) to a non-default password,
- B. smartphone users must enable Airplane Mode,
- C. on ROBOT CONTROLLER and DRIVER STATION Android devices, Wi-Fi must be enabled and Bluetooth must be disabled,
- D. on smartphones and REV Driver Hub, remove all remembered Wi-Fi Direct Groups and Wi-Fi connections, leaving only the ROBOT CONTROLLER Wi-Fi connection.

12.8 Pneumatic Systems

In order to maintain safety, the rules in this section apply at all times while at the event, not just while the ROBOT is on the FIELD for MATCHES.

R801 *No Pneumatics. No closed air systems are allowed on *FIRST* Tech Challenge ROBOTS except for those explicitly listed in [R207](#).

12.9 OPERATOR CONSOLE

- R901** *Use only a specified DRIVER STATION device. The OPERATOR CONSOLE may only have one approved android-based DRIVER STATION device connected and powered on. The OPERATOR CONSOLE must have at least one of the following:
- REV Driver Hub (REV-31-1596) or
 - Approved Android Device from rule [R704](#) with one OTG cable and COTS USB cable to connect the required gamepad controller(s).
- Teams who wish to have a spare DRIVER STATION device as part of their OPERATOR CONSOLE may do so as long as only one DRIVER STATION device is connected and powered on at a time.
- R902** *The OPERATOR CONSOLE must make the touch screen accessible. The OPERATOR CONSOLE, the set of COMPONENTS and MECHANISMS used by the DRIVE TEAM to relay commands to the ROBOT, must make the touch screen of the DRIVER STATION device accessible. The DRIVER STATION device must be positioned within the OPERATOR CONSOLE so that the screen display can be clearly seen during inspection and in a MATCH. The DRIVER STATION device touch screen must be functional without the requirement of additional aides (e.g., mouse) in order to be used.
- R903** *Options for portable power to the DRIVER STATION device are limited. The DRIVER STATION device can be charged onboard the OPERATOR CONSOLE using one (1) COTS USB external battery as long as the following requirements are met:
- COTS USB battery adheres to capacity limits in [R602](#) and usage in [R602-A](#) and [R602-B](#)
 - DRIVER STATION device is connected to the COTS USB external battery through the built-in USB-C port on the REV Driver Hub or through a USB Hub connected to the smartphone Android Device.
- R904** *Only limited gamepads are supported. The OPERATOR CONSOLE may have no more than two (2) electrically unmodified gamepads in any combination from the following list connected to the DRIVER STATION at any time:

Table 12-12: Allowed Gamepads on OPERATOR CONSOLE

Gamepad	Part Number	Notes
Logitech F310 gamepad	940-00010	
Xbox 360 Controller for Windows	52A-00004	
Sony DualShock 4 Wireless Controller for PS4	N/A	Operating in wired mode only (i.e., connected through USB cable without being Bluetooth paired to any device)
Sony DualSense Wireless Controller for PS5	N/A	This DOES NOT include the Sony DualSense Edge Wireless Controller in any configuration
Etpark Wired Controller for PS4	REV-39-1865	
REV Robotics USB PS4 Compatible Gamepad	REV-31-2983	

Gamepad	Part Number	Notes
Quadstick game controller in Xbox 360 Emulation Mode	any model	

Enhancements to the gamepad that do not modify the electronics are legal. Different color gamepads are allowed provided they are the same model as the allowed gamepad.

Teams are strongly encouraged to use short USB cable extenders with the USB ports on the DRIVER STATION device. These extenders are used to reduce the wear and tear on the DRIVER STATION device ports from frequent plugging and unplugging – instead of plugging/unplugging directly into the DRIVER STATION device, gamepads are plugged and/or unplugged from the cable extenders. The extenders are intended to remain forever plugged into the DRIVER STATION device and, with proper strain relief employed, can protect the port from accidental damage.

Teams who wish to have spare gamepad(s) available as part of their OPERATOR CONSOLE may do so as long as no more than two gamepads are connected at any time.

R905 *OPERATOR CONSOLE physical requirements. The OPERATOR CONSOLE must not

- A. include more than one (1) connected external USB hub,
- B. contain any non-decorative electronics not otherwise required, or
- C. exceed a volume of 3ft wide, 1ft deep and 2 ft tall (91.4cm by 30.5cm by 61.0 cm) excluding any items that are held or worn by the DRIVERS during the MATCH

Please note that while there is no hard weight limit, OPERATOR CONSOLES that weigh more than 20 lbs. (~9 kg.) will invite extra scrutiny as they are likely to present unsafe circumstances.

Teams who wish to have a spare external USB hub as part of the OPERATOR CONSOLE may do so as long as only one USB hub is connected at any time.

R906 *ROBOT application wireless communication only. Other than the connection controlled by the ROBOT CONTROLLER app running on the ROBOT and the DRIVER STATION app running on the DRIVER STATION device, no other form of wireless communications shall be used to communicate to, from, or within the OPERATOR CONSOLE during a MATCH.

Examples of prohibited wireless systems include, but are not limited to, active wireless network cards and Bluetooth devices.

Because this system uses a built-in wireless radio, teams are strongly encouraged to ensure there is no metal material blocking the line-of-sight between the DRIVER STATION device and the ROBOT CONTROLLER device which could impede the signal quality.

R907 *No unsafe OPERATOR CONSOLES. OPERATOR CONSOLES shall not be made using hazardous materials, be unsafe, cause damage, cause an unsafe condition, distract, or interfere with other DRIVE TEAMS or the operation of other ROBOTS.

DRIVER STATION sounds which are distracting or which mimic MATCH sounds are examples of disallowed OPERATOR CONSOLE features.

Sounds which are frequent or continuous which serve no apparent value to the MATCH play would likely be considered distracting.

The intent of this rule is to allow teams to use a container to store, organize, and transport the DRIVER STATION device and supporting electronics. The OPERATOR CONSOLE rules are not intended to allow systems that function as a ROBOT cart or replace a competition-provided OPERATOR CONSOLE stand, table, etc.



13 Tournament (T)

13.1 Overview

Each *FIRST* Tech Challenge competition is played in a head-to-head tournament format. Each tournament may consist of qualification MATCHES and playoff MATCHES.

Qualification MATCHES allow each team to earn MATCH points and RANKING POINTS which determine their seeding position and may qualify them for participation in the playoff MATCHES.

Playoff MATCHES determine the event winning ALLIANCE.

These rules apply to all event types described in section [4 Advancement](#). Additional rules may apply to League Meets and League Tournaments as covered by section [14 League Play Tournaments \(L\)](#).

13.2 General Tournament Rules

T201 *The Head REFEREE has ultimate and final authority regarding gameplay during the event. The Head REFEREE may receive input from additional sources, e.g., *FIRST* personnel, FTA, Event Director, Program Delivery Partner, and other event staff. The Head REFEREE rulings are final. No event staff, including the Head REFEREE, will review video, photos, artistic renderings, etc. of any MATCH, from any source, under any circumstances.

- A. When issuing a RED CARD or YELLOW CARD the Head REFEREE must record the rule violation.
- B. Event Directors and Program Delivery Partners may not overrule a Head REFEREE decision.
- C. *FIRST* Code of Conduct and Egregious violations may involve escalation beyond the Head REFEREE'S initial ruling.
- D. Every qualification and playoff MATCH must be observed by a certified Head REFEREE. Head REFEREES may only watch one MATCH at a time.

Rules in this manual are written for *human* Head REFEREES to enforce. Some have clear unambiguous criteria which can be easily checked, but other rules will rely on human judgement. Head REFEREES are asked to make the best call they can in the moment with what they or other REFEREES observed during the MATCH.

When there is an ambiguous situation or controversial call it is human instinct to wonder what was the “right call” or “what-if..” – for the purposes of *FIRST* Tech Challenge gameplay, the right call is the one that was made in good faith by the Head REFEREE with the information they had available at the time.

T202 *Only REFEREES can declare a ROBOT DISABLED. A ROBOT is only considered DISABLED once a REFEREE has declared the ROBOT DISABLED during a MATCH. A ROBOT may be DISABLED as a consequence of a rule violation or due to a ROBOT failure. If a REFEREE DISABLES a ROBOT as a consequence for a rule violation, the REFEREE may instruct the team to drive the ROBOT to a specific neutral position on the FIELD before DISABLING.

T203 The Event Director has ultimate authority regarding all non-gameplay decisions during an event. The Competition Manual is intended to provide a set of rules for the competition including gameplay and judging but it is not an exhaustive compilation of guidelines for running a *FIRST* Tech Challenge event.

Issues outside of specific gameplay rules which are under the authority of the Head REFEREE per [T201](#) are at the discretion of the Event Director such as, but not limited to:

- A. venue access as published via the public schedule
- B. pit sizes and utility access
- C. health and safety
- D. team registration and competition eligibility
- E. team conduct away from the fields

T204 All competition FIELDS at an event must be consistent with each other. Events which have multiple competition FIELDS (as indicated by the MATCH schedule Figure 13-1) will be consistent with each other. Examples of set-up which must be considered includes but is not limited to:

- A. elevation of the FIELD off the floor
- B. FIELD display monitors
- C. FIELD perimeter type
- D. FIELD TILE size and type

Other FIELDS at the event do not need to be consistent with each other or competition FIELDS.

T205 *During optional FIELD measurement and calibration time(s) ROBOTS may not practice on the FIELD. During any period when the ARENA is open for measurement, ROBOTS may run OpModes but cannot interact with (e.g., score, push, pickup) SCORING ELEMENTS, or other FIELD elements.

Violation: Verbal warning, plus YELLOW CARD if subsequent violations at any point during the event or egregious.

At the discretion of the Head REFEREE at the event, the ARENA may be open for at least 30 minutes prior to the start of qualification MATCHES, during which time teams may survey and/or measure the ARENA and bring ROBOTS on the FIELD to perform sensor calibration. The specific time that the FIELD is open will be communicated to teams at the event. Teams may bring specific questions or comments to the Head REFEREE or FTA.

ROBOT calibration and measurements can also be completed during scheduled field inspection times, as long as all teams get roughly the same time regardless of inspection length.

T206 *Back-to-back MATCHES have breaks. Teams playing in back-to-back MATCHES will have a minimum break between MATCHES as follows:

- A. qualifications MATCHES will have a minimum of five (5) minutes from when the scores are posted until when the ROBOT must be placed on the FIELD for the next MATCH.
- B. playoff MATCHES will have a minimum of eight (8) minutes from when scores are posted until when the ROBOT must be placed on the FIELD for the next MATCH.

13.3 MATCH Replays

T301 *Replays are allowed, but rare. MATCH replays are only allowed in extreme circumstances due to an ARENA FAULT or for MATCHES which are stopped because FIELD STAFF anticipated FIELD damage or personal injury.

An ARENA FAULT is an error in ARENA operation that includes, but is not limited to:

- A. broken FIELD elements due to normal, expected game play or ROBOT abuse of FIELD elements that affects the outcome of the MATCH for their opponents,

A broken FIELD element caused by ROBOT abuse that affects the outcome of the MATCH for their ALLIANCE is not an ARENA FAULT.

- B. FIELD elements moving beyond normal tolerances (not as the result of ROBOT interaction)
- C. Wide-spread wireless interference affecting multiple ROBOTS typically at the same time and on both ALLIANCES,
- D. failure of the MATCH timer display, or
- E. errors by FIELD STAFF (except those listed in section [10.8 Other Logistics](#))

To replay a MATCH the Head REFEREE must determine that an ARENA FAULT which is MATCH affecting has occurred and a team on the affected ALLIANCE must request the replay. In addition, FIRST Headquarters reserves the right to, with consultation of the Head REFEREE and FIELD STAFF, replay any MATCH in which an ARENA FAULT impacts the outcome of an event.

Unexpected ROBOT behavior which is the fault of the team are not justifications for a replay. Conditions such as, but not limited to low ROBOT battery, programming issues or ROBOT mechanical problems are not grounds for a replay.

The outcome of the MATCH is affected if an error occurs that, in the judgement of the Head REFEREE, changes which ALLIANCE would have won the MATCH.

The outcome of an event is affected if an error occurs that, in the judgement of FIRST Headquarters, has a dramatic effect on points used for ranking criteria.

Note that an ARENA FAULT that does not affect MATCH outcome, in the judgement of the Head REFEREE, does not lead to a MATCH replay. Examples include, but are not limited to:

- A. a piece of FIELD plastic falls into the FIELD, far away from any human or ROBOT activity, and in such a way that it does not affect MATCH outcome,
- B. delay in the playing of an ARENA sound, and
- C. any adjustment or delay in assignment of a penalty or scoring achievement (including those made after the MATCH).

T302 *Replays will replicate the conditions of the original MATCH. All reasonable effort is made to create the same conditions when replaying a MATCH caused by an ARENA FAULT or FIELD damage. This includes:

- A. a ROBOT that was not present for the MATCH or DISABLED prior to the start of the original MATCH, which is to be replayed, is DISABLED for the replay MATCH
- B. the same FIELD will be used unless at the discretion of the Head REFEREE due to severity of FIELD damage

Exceptions to this rule are:

- C. ROBOT and DRIVE TEAM starting locations do not need to be replicated when replaying a MATCH

While efforts will be made to replicate the same conditions of the original MATCH, there are environmental factors, such as changes to ambient lighting, that may be outside the control of the event.

13.4 Clarifications on MATCH Play Results (“Question Box”)

Each event will have one or more designated Question Boxes in the ARENA area. If a DRIVE TEAM has a question about a MATCH, the FIELD, etc., they may send one STUDENT wearing a DRIVE TEAM badge to their corresponding Question Box. Depending on timing, the Head REFEREE or FTA may postpone any requested discussion until the end of the subsequent MATCH.

Technical questions regarding FIELD or ROBOT operation are addressed by the FTA, and additional team members are invited to participate in these conversations if necessary. If a DRIVE TEAM needs clarification on a ruling or score, per [T401](#), one STUDENT should address the Head REFEREE after the MATCH results have been shown.

While the *FIRST* event management software tracks quantities of MINOR and MAJOR FOULS, *FIRST* instructs REFEREES to not self-track details about MINOR FOULS and MAJOR FOULS; as a result, we do not expect REFEREES to recall details about what MINOR FOULS and MAJOR FOULS were made, when they occurred, and against whom.

Any reasonable question is fair game in the Question Box, and Head REFEREES will make good faith efforts to provide helpful feedback (e.g., how/why certain FOULS are being called, why a particular ROBOT may be susceptible to certain FOULS based on its design or gameplay, how specific rules are being called or interpreted), but please know that they may not be able to supply specific details.

T401 *1 STUDENT, 1 Head REFEREE. A team may only address the Head REFEREE with 1 STUDENT. The STUDENT may be accompanied by at most 1 silent observer, who may be an adult or a STUDENT.

Violation: The Head REFEREE will not address additional, non-compliant team members or peripheral conversations.

T402 *MATCH questions must be timely. If a team would like to clarify or dispute the results of a MATCH using the process per [T401](#) they must present their STUDENT representative in the question box in a timely manner as outlined below:

- A. questions regarding events in a qualification MATCH may be asked at any time before ALLIANCE selection begins, or within 5 minutes of the last qualification MATCH at events without playoff MATCHES
- B. questions regarding events in a playoff MATCH must be asked before the current round is finished.

Please keep in mind that our REFEREES are human, and the more time has passed between the MATCH in questions, the less likely they are to remember the details of a specific MATCH. It is best to ask for clarification or to dispute the results of a MATCH within 3 MATCHES.

T403 *Keep questions factual and constructive. Teams coming to the Question Box should think through their requests in advance and are encouraged to have relevant references to rules or the Q&A website available to aid discussions.

There should be no negative implications for teams using the question box to advocate for themselves, but everyone should keep in mind it can be a high stress situation for team youth and for volunteers alike and it is important to remember our [Core Values](#) during these discussions.

13.5 Qualification MATCHES

13.5.1 Schedule

The qualification MATCH schedule is made available as soon as possible, but no later than 15 minutes before qualification MATCHES are scheduled to begin. Only teams who are eligible and have completed check-in on time will be included in the schedule per [I102](#) and [E105](#). Teams will receive access to the schedule through one or more of the following methods: one (1) printed hard copy, notice of publicly posted hardcopy available to photograph, and/or local digital schedule display. Schedules may also be available on the [FIRST Tech Challenge Events](#) site if the tournament is connected to the internet. Each qualification schedule consists of a series of rounds in which each team plays one (1) MATCH per round.

All event types will schedule either five (5) or six (6) qualification MATCHES per team as determined by the Event Director based on available schedule time allocated. *FIRST* Championship and Regional Championship Tournaments may schedule more MATCHES per team at the discretion of *FIRST* Headquarters and the Event Director.

A MATCH schedule is used to coordinate MATCHES at an event. Figure 13-1 details information shown on each schedule. SURROGATE MATCHES are described in section [13.5.2 MATCH Assignment](#).

Figure 13-1: Sample MATCH Schedule

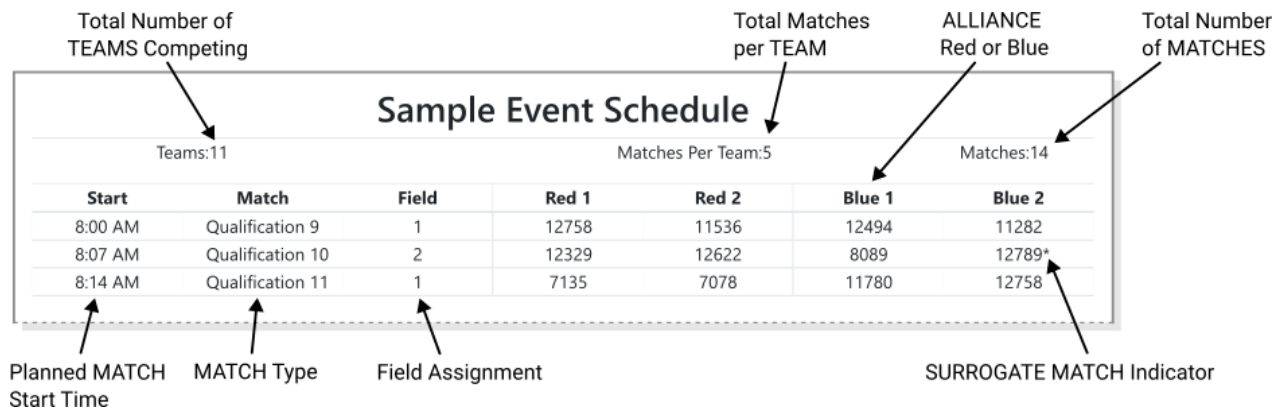

Start	Match	Field	Red 1	Red 2	Blue 1	Blue 2
8:00 AM	Qualification 9	1	12758	11536	12494	11282
8:07 AM	Qualification 10	2	12329	12622	8089	12789*
8:14 AM	Qualification 11	1	7135	7078	11780	12758

13.5.2 MATCH Assignment

FIRST event management software assigns each team one (1) ALLIANCE partner for each qualification MATCH using a predefined algorithm, and teams may not switch qualification MATCH assignments. The algorithm employs the following criteria, listed in order of priority:

1. ensure each team has at least the minimum required time between MATCHES (varies by event size)
2. minimize the number of times a team is allied with any team
3. minimize the number of times a team plays opposite any team
4. minimize the use of SURROGATES (teams randomly assigned by event management software to play an extra qualification MATCH)

5. provide even distribution of MATCHES played on blue and red ALLIANCE

For more information about the MATCH scheduling algorithm, please see [Idle Loop software's website](#).

All teams are assigned the same number of qualification MATCHES, equal to the number of rounds, unless the number of teams multiplied by number of MATCHES is not divisible by 4. In this case, the *FIRST* event management software randomly selects some teams to play an extra MATCH. For the purpose of seeding calculations, those teams are designated as SURROGATES for the extra MATCH. If a team plays a MATCH as a SURROGATE, it is indicated on the MATCH schedule with an * after their team number, it is always their third qualification MATCH, and the outcome of the MATCH has no effect on the team's ranking. YELLOW and RED CARDS assigned to SURROGATES, however, do carry forward to subsequent MATCHES.

If a team is scheduled to play in a back-to-back MATCHES (e.g., qual MATCH 40 and 41) they will receive a minimum break per [T206](#) before their next MATCH.

13.5.3 Qualification Ranking

RANKING POINTS (RP) are units credited to a team based on their ALLIANCE'S performance in qualification MATCHES. These points are awarded to each eligible team at the completion of each qualification MATCH per Table 10-3.

A team's RANKING SCORE (RS) is the average number of RANKING POINTS earned by a team throughout their qualification MATCHES (excluding any SURROGATE MATCH).

All teams participating in qualification MATCHES are ranked by RANKING SCORE. If the number of teams in attendance is 'n', they are ranked '1' through 'n', with '1' being the team with the highest RANKING SCORE and 'n' being the team with the lowest RANKING SCORE. SURROGATE MATCHES are excluded from all calculations. A MATCH in which a team is DISQUALIFIED contributes 0 to all sort criteria.

Teams are ranked in order, using the sorting criteria defined in Table 13-1.

Table 13-1: qualification MATCH ranking criteria

Order Sort	Criteria
1 st	RANKING SCORE (RS)
2 nd	Average ALLIANCE AUTO Points
3 rd	Average TELEOP ALLIANCE ASCENT Points
4 th	Highest MATCH Score (including FOULS)
5 th	Random sort by the <i>FIRST</i> event management software

T501 *DISQUALIFICATION applies only to the DISQUALIFIED team in qualifications. During qualification MATCHES, a team DISQUALIFICATION has no effect on their ALLIANCE partner.

13.6 Playoff MATCHES

Playoff MATCHES follow the qualification MATCHES. In the playoffs, teams play on set ALLIANCES, chosen during ALLIANCE selection, and advance through a double elimination bracket to determine an event winner. Teams do not earn RANKING POINTS; they advance based on winning or losing MATCHES. If a team is DISQUALIFIED during playoff MATCHES, the DISQUALIFICATION applies to the entire ALLIANCE and all teams in the ALLIANCE receive 0 MATCH points.

T601 *Send a STUDENT representative. Each team must choose and send a STUDENT team representative to the ARENA at the designated ALLIANCE selection time (typically just after the last scheduled qualification MATCH) to represent their team.

Violation: Teams who do not send a representative are ineligible for the playoff tournament

If an absent team would have been an ALLIANCE lead, all lower ranked ALLIANCE leads are promoted 1 spot.

If a team is planning to not participate in the playoff tournament, they should proactively inform the Event Director and Head REFEREE as soon as possible.

T602 *Declining teams cannot be picked. An ALLIANCE CAPTAIN may not invite a team that has declined another ALLIANCE'S invitation to participate in the playoff tournament.

Violation: The ALLIANCE CAPTAIN must make another selection

An ALLIANCE lead that declines an invitation from another ALLIANCE is able to invite teams to join their ALLIANCE but may not be invited to join another ALLIANCE.

T603 *There are no backup teams in playoff MATCHES. An ALLIANCE may not request a backup team in a playoff MATCH.

Teams are encouraged to consider reliability when selecting partners because all teams on an ALLIANCE must play in each round of the playoff tournament.

T604 *During playoff MATCHES, teams may have more ARENA access. During the playoff MATCHES teams may need extra team members to maintain the ROBOT between MATCHES in a timely manner. Each team is permitted to have up to 3 additional pit crew members to help with needed ROBOT repairs. These team members should be granted the same ARENA access as the DRIVE TEAM but may not participate in any MATCH play.

This allocation of additional pit crew members is venue specific and at the discretion of the Event Director.

T605 *Multiple DISQUALIFICATION is handled specially. During playoff MATCHES, one or more ALLIANCE DISQUALIFICATIONS are handled accordingly:

- A. if one ALLIANCE is DISQUALIFIED, the DISQUALIFIED ALLIANCE loses
- B. if both ALLIANCES are DISQUALIFIED, the one that is DISQUALIFIED first chronologically loses
- C. if, in the judgement of the Head REFEREE, both ALLIANCES are simultaneously DISQUALIFIED, the MATCH results in a tie

13.6.1 ALLIANCE Selection Process

At the end of the Qualification MATCHES, the top ranked teams become the ALLIANCE leads. The designated STUDENT representative from each ALLIANCE lead is called the ALLIANCE CAPTAIN. This representative may change between ALLIANCE selection and playoff MATCHES.

The ranked ALLIANCES are designated, in order, ALLIANCE 1, ALLIANCE 2, etc., down to the maximum number of ALLIANCES shown in Table 13-2. Using the ALLIANCE selection process described in this section, each ALLIANCE lead chooses 1 other team to join their ALLIANCE.

If the team accepts, it becomes a member of that ALLIANCE. If an invitation from an ALLIANCE lead to another ALLIANCE lead is accepted, all lower ALLIANCE leads are promoted 1 spot. The highest-ranked, unselected team becomes the newest ALLIANCE lead.

13.6.2 Playoff MATCH Bracket

The playoff MATCH bracket is how the event winners are determined.

The number of ALLIANCES for an event is determined by the number of teams who are eligible to participate in the playoffs as shown in Table 13-2.

Table 13-2: Number of playoff ALLIANCES based on total playoff eligible teams

Total playoff eligible teams	Number of playoff ALLIANCES formed
4-10 Teams	2
11-20 Teams	4
21-40 Teams	6
41-64 Teams	8

See section [13.7 Dual Division Events](#) for the additional dual division related rules.

The double elimination tournament consists of an upper and lower bracket that will scale based on the number of ALLIANCES. Tournaments with 2 ALLIANCES will have those ALLIANCES face each other in the finals.

Each ALLIANCE begins in the upper bracket. If an ALLIANCE wins a MATCH in the upper bracket, they remain in the upper bracket. If an ALLIANCE loses a MATCH in the upper bracket, they transition to the lower bracket. ALLIANCES in the lower bracket must win all subsequent MATCHES to remain in the tournament, i.e., once they lose two total MATCHES, they are out of the tournament.

Ties play another MATCH until the MATCH results in one winner.

In Round 1, the higher ranked ALLIANCE is assigned to the red ALLIANCE. For subsequent rounds, ALLIANCE color is assigned as shown in Figure 13-2, regardless of ALLIANCE rank at the start of the playoff tournament.

As shown in Figure 13-2, playoff MATCHES consist of up to six (6) rounds with breaks between later rounds. Breaks begin after the score has been posted from the latest MATCH. The Blue and Red Gap columns indicate the approximate time between each ALLIANCE'S MATCHES. The expected start time of the scheduled MATCH is the time indicated on the MATCH schedule or 8 minutes from the end of either ALLIANCE'S previous MATCH, whichever is later per [T206](#).

Figure 13-2 8-ALLIANCE playoff bracket

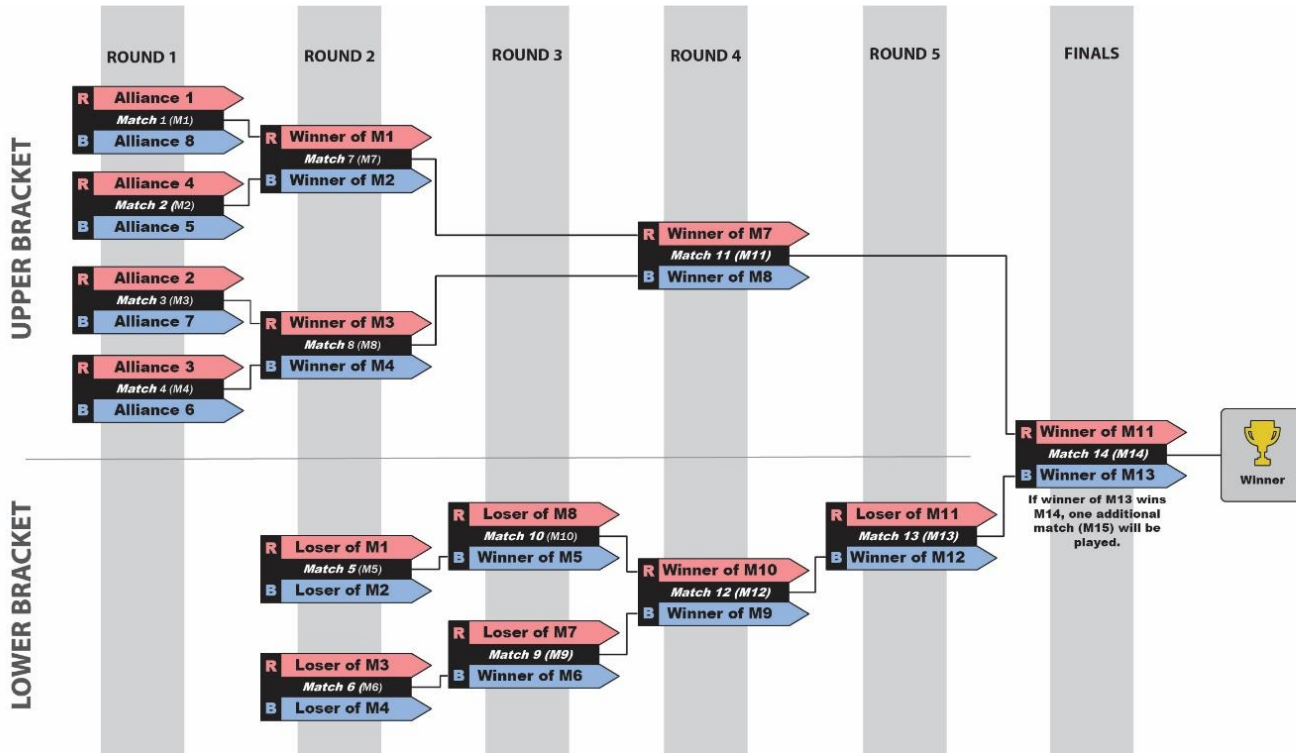

If a playoff MATCH needs to be replayed as described in section [13.3 MATCH Replays](#) or an additional MATCH needs to be played due to tie, teams are notified of when the MATCH will occur. A minimum 8-minute delay is provided for teams to reset their ROBOTS prior to the MATCH unless all teams are ready sooner ([T206](#)). The affected MATCH must be played before the next round begins.

13.6.3 2-ALLIANCE Bracket and Typical Timing

Figure 13-3: 2-ALLIANCE playoff bracket

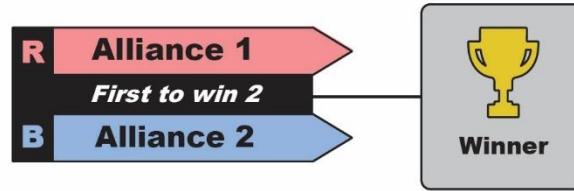

Table 13-3: 2-ALLIANCE playoff bracket typical timing

Round	MATCH	Upper/ Lower	Gap (min)					Next MATCH (MATCH # (ALLIANCE color))		Estimated Start (min)
			FIELD	Blue	Red	Blue	Red	Winner	Loser	
15-minute break			Judges' Choice* (1), Innovate/Design/Control Award (1)							0
Finals	1		1	A2	A1			M2	M2	15
15-minute break			Motivate/Connect Award (1)							18
Finals	2		1	A2	A1	0:15	0:15	M3*	M3*	33
10-minute break			Think Award (1)							36
Finals	3*		1	A2	A1	0:10	0:10			46
Awards: Compass*, Finalists, Winners, and Inspire Award (1)										49

* if required

**Awards may be given out after the conclusion of the playoff bracket at the discretion of the Event Director.

13.6.4 4-ALLIANCE Bracket and Typical Timing

Figure 13-4: 4-ALLIANCE playoff bracket

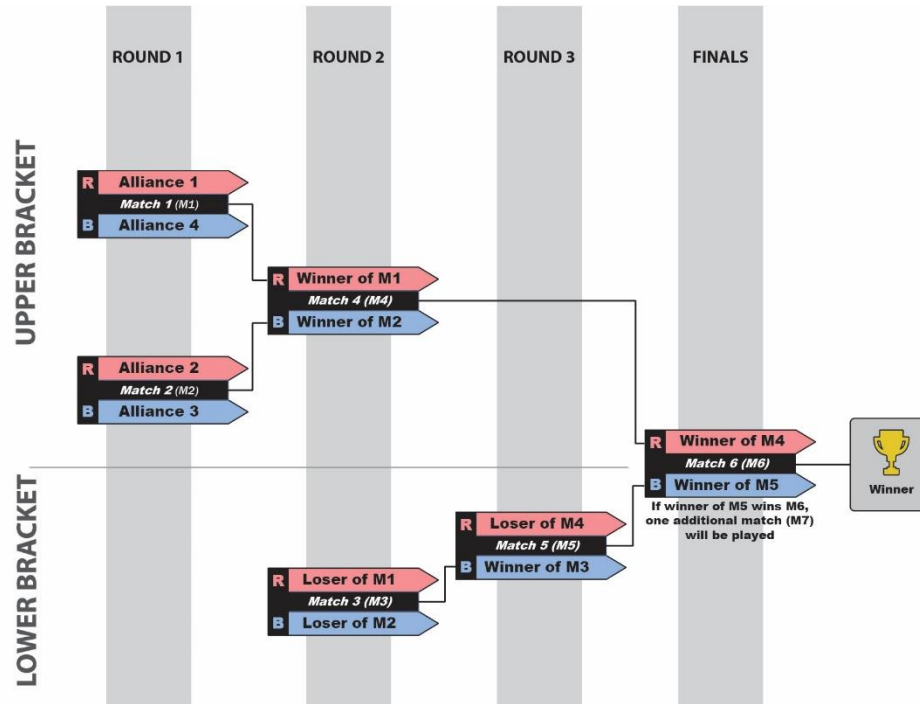

Table 13-4: 4-ALLIANCE playoff typical timing

Round	MATCH	Upper/ Lower	FIELD	Gap (min)				Next MATCH (MATCH # (ALLIANCE color))		Estimated Start (min)
				Blue	Red	Blue	Red	Winner	Loser	
1	1	Upper	1	A4	A1			M4 (R)	M3 (R)	0
	2	Upper	1	A3	A2			M4 (B)	M3 (B)	6
8-minute break										9
2	3	Lower	1	L2	L1	0:08	0:14	M5 (B)	4th	17
	4	Upper	1	W2	W1	0:14	0:20	M6 (R)	M5 (R)	23
15-minute break										26
Judges' Choice* (1), Design Award (1), Motivate Award (1)										
3	5	Lower	1	W3	L4	0:21	0:15	M6 (B)	3rd	41
15-minute break										44
Control Award (1), Innovate Award (1)										
Finals	6		1	W5	W4	0:15	0:33	M7*	M7*	59
15-minute break										62
Connect Award (1), Think Award (1)										
Finals	7*		1	W5	W4	0:15	0:15			77
Awards: Compass*, Finalists, Winners, and Inspire Award (2, 1)										80

*If Required

**Awards may be given out after the conclusion of the playoff bracket at the discretion of the Event Director.

13.6.5 6-ALLIANCE Bracket and Typical Timing

Figure 13-5: 6-ALLIANCE playoff bracket

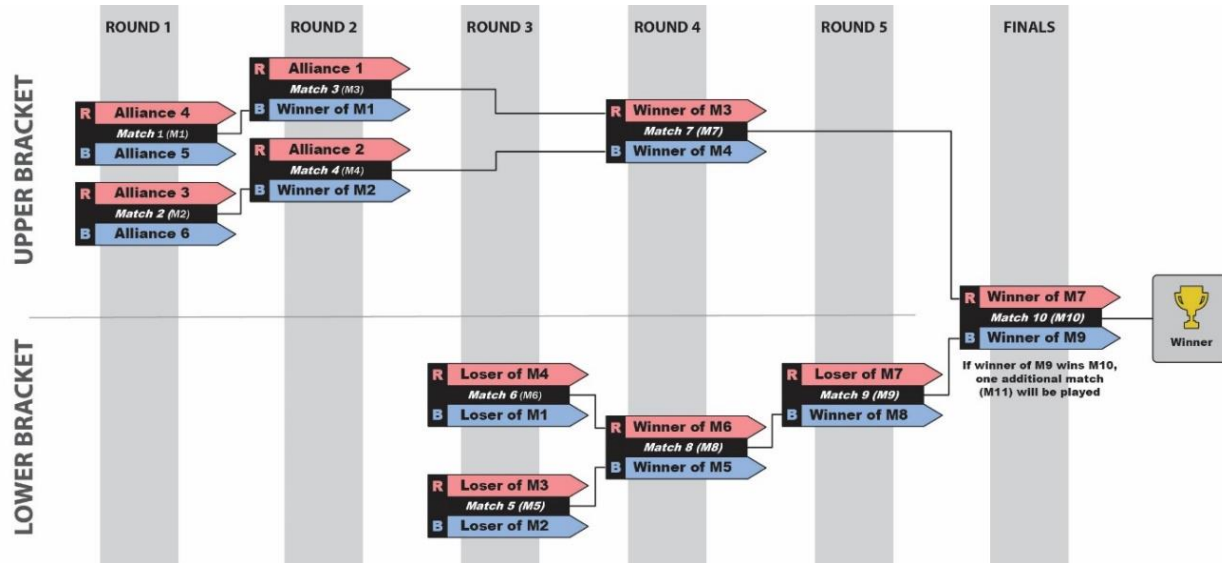

Table 13-5: 6-ALLIANCE playoff bracket typical timing

Round	MATCH	Upper/ Lower	FIELD	Gap (min)				Next MATCH (MATCH # (ALLIANCE color))		Estimated Start (min)
				Blue	Red	Blue	Red	Winner	Loser	
1	1	Upper	1	A5	A4			M3 (B)	M6 (B)	0
	2	Upper	2	A6	A3			M4 (B)	M5 (B)	6
2	3	Upper	1	W1	A1	0:09		M7 (R)	M5 (R)	12
	4	Upper	2	W2	A2	0:09		M7 (B)	M6 (R)	18
3	5	Lower	1	L2	L3	0:15	0:09	M8 (B)	Tied 5th	24
	6	Lower	2	L1	L4	0:27	0:09	M8 (R)		30
4	7	Upper	1	W4	W3	0:15	0:21	M10 (R)	M9 (R)	36
	8	Lower	2	W5	W6	0:15	0:09	M9 (B)	4th	42
15-minute break			Judges' Choice* (1), Design Award (2, 1), Motivate Award (2, 1)							45
5	9	Lower	1	W8	L7	0:15	0:21	M10 (B)	3rd	60
15-minute break			Control Award (2, 1), Innovate Award (2, 1)							63
Finals	10		1	W9	W7	0:15	0:39	M11*	M11*	78
15-minute break			Connect Award (2, 1), Think Award (2, 1)							81
Finals*	11		1	W9	W7	0:15	0:15			96
Awards: Compass*, Finalists, Winners, and Inspire Award (3, 2, 1)										99

* if required

**Awards may be given out after the conclusion of the playoff bracket at the discretion of the Event Director.

13.6.6 8-ALLIANCE Bracket and Typical Timing

Figure 13-6: 8-ALLIANCE playoff bracket

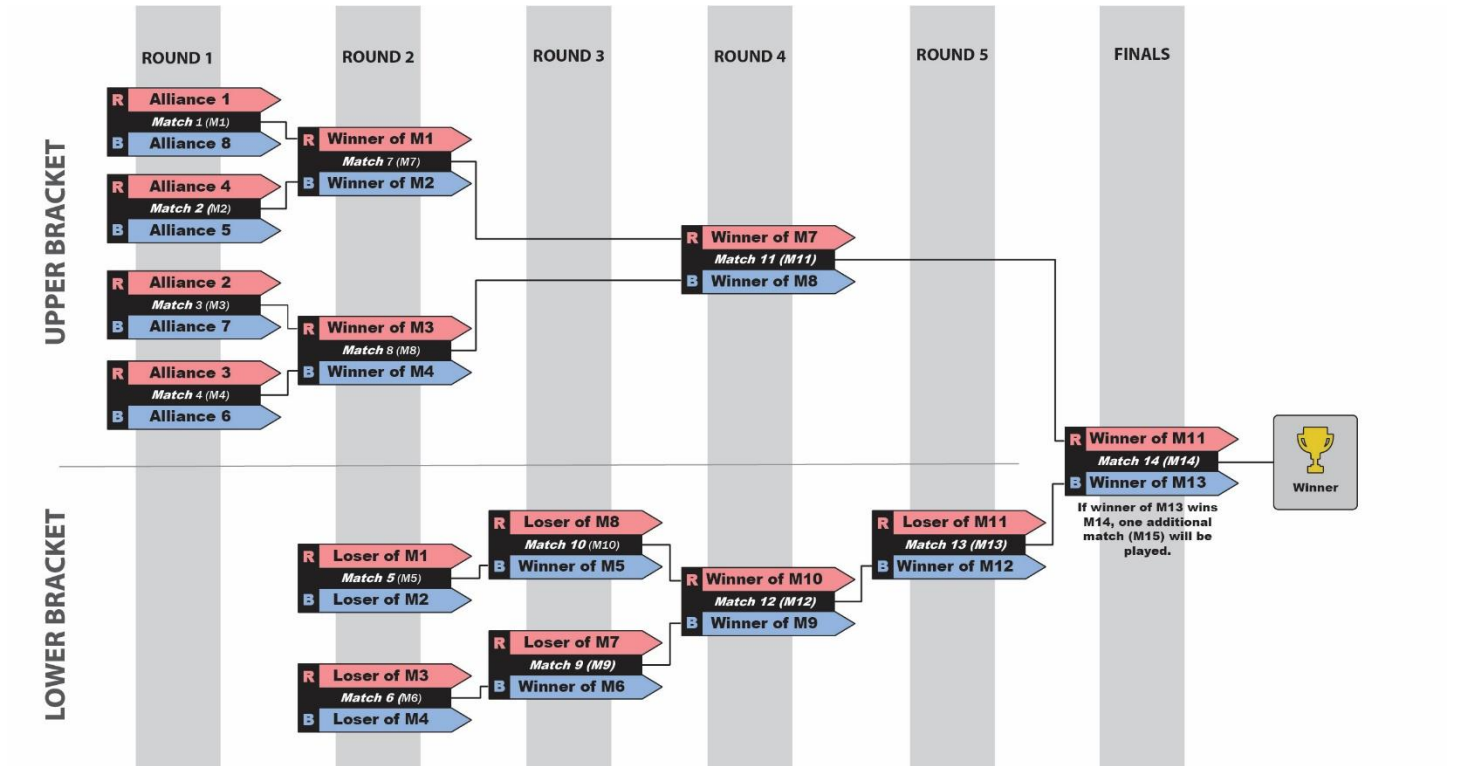

Table 13-6: 8-ALLIANCE playoff bracket typical timing

Round	MATCH	Upper/ Lower	FIELD	Gap (min)				Next MATCH (MATCH # (ALLIANCE color))		Estimated Start (min)
				Blue	Red	Blue	Red	Winner	Loser	
1	1	Upper	1	A8	A1			M7 (R)	M5 (R)	0
	2	Upper	2	A5	A4			M7 (B)	M5 (B)	6
	3	Upper	1	A7	A2			M8 (R)	M6 (R)	12
	4	Upper	2	A6	A3			M8 (B)	M6 (B)	18
2	5	Lower	1	L2	L1	0:15	0:21	M10 (B)	Tied 7th	24
	6	Lower	2	L4	L3	0:09	0:15	M9 (B)		30
	7	Upper	1	W2	W1	0:27	0:33	M11 (R)	M9 (R)	36
	8	Upper	2	W4	W3	0:21	0:27	M11 (B)	M10 (R)	42
3	9	Lower	1	W6	L7	0:15	0:09	M12 (B)	Tied 5th	48
	10	Lower	2	W5	L8	0:27	0:09	M12 (R)		54
4	11	Upper	1	W8	W7	0:15	0:21	M14 (R)	M13 (R)	60
	12	Lower	2	W9	W10	0:15	0:09	M13 (B)	4th	66
15-minute break		Judges' Choice* (1), Design Award (3,2,1), Motivate Award (3,2,1)								69
5	13	Lower	1	W12	L11	0:15	0:21	M14 (B)	3rd	84
15-minute break		Control Award (3,2,1), Innovate Award (3,2,1)								87
Finals	14		1	W13	W11	0:15	0:39	M15*	M15*	102
15-minute break		Connect Award (3,2,1), Think Award (3,2,1)								105
Finals*	15		1	W13	W11	0:15	0:15			120
Awards: Compass*, Finalists, Winners, and Inspire Award (3, 2, 1)										123

* if required

**Awards may be given out after the conclusion of the playoff bracket at the discretion of the Event Director.

13.7 Dual Division Events

Dual Division events are typically larger events which run as two different competition events (e.g., two parallel Qualifying Tournaments) with concurrent judging for all teams. After the playoff MATCHES have concluded in each division, the two division winning ALLIANCES compete to determine the overall event winner.

Advancement from a Dual Division event is defined in Table 4-1.

In Dual Division events, teams can be assigned to division in a few different methods briefly described below. For complete details reference the event management software documentation. The method used is at the discretion of the local Program Delivery Partner.

- A. **Random Assignment** – Random division assignment take the team list, shuffles it, and splits the list in half. If equal division sizes cannot be made, the software randomly chooses which division will have an extra team.
- B. **FIM Method** – Algorithm is based on the process developed by FIRST in Michigan (FIM) and utilizes a "brute force randomizer" approach. It attempts to balance ROBOT performance while

maintaining a decent factor of randomness. Teams are ranked based on a qualification performance metric based on the two best events and then assigned to quartiles and distributed between divisions such that each quartile is equally represented. Division assignments are measured against several metrics to ensure divisions are closely matched.

- C. **Alternating Assignment** – Alternating division assignment sorts the team list by team number, then assigns teams by alternating divisions while iterating through the team list. The lowest team number will be assigned Division 1, the next Division 2, then Division 1, etc.
- D. **Child League Split-up** (only available for League Tournaments) – Algorithm attempts to balance the representation of each child league in each division.
- E. **OPR Method** – Algorithm attempts to balance the ROBOT performance across the division. It calculates every team’s Offensive Power Rating (OPR) for every official event they competed in for the current season and selects each team’s highest OPR. Then it ranks all the teams by highest OPR and alternately assigns teams from highest to lowest OPR into each division.
- F. **Manual** – The Program Delivery Partner can upload a list of manually assigned teams.

In addition to rules listed in previous manual sections, Dual Division event have the following rules:

- T701 ***Divisions will use the same size playoff brackets.** The number of playoff ALLIANCES will be determined based on the number of playoff eligible teams in the smaller division as shown in Table 13-2.
- T702 ***Dual-Division awards are given at the event level.** All awards are judged and awarded at the tournament level, not the division level.
- T703 ***Dual-Division award counts are based on total teams.** The number of awards distributed at a Dual Division event is determined using Table 6-1.

13.7.1 Dual Division playoffs

Each division plays a standard tournament as described in section [13.5 Qualification MATCHES](#) followed by division playoffs to produce the Division Winning ALLIANCE. Those two Division Winners have their win-loss records reset and proceed to play each other in a 2-ALLIANCE double eliminations bracket.

Divisions are ranked by the criteria in Table 13-1 excluding Rank Score.

Figure 13-7: 2-ALLIANCE grand finals playoff bracket (Dual Division)

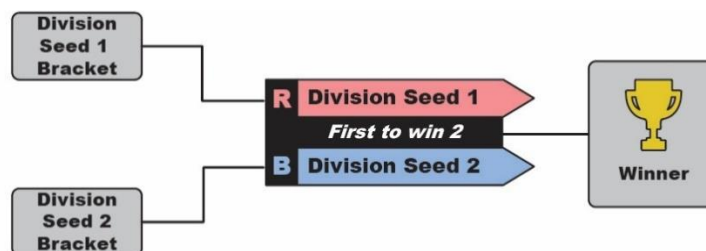

Table 13-7: 6-ALLIANCE Dual Division playoff bracket typical timing

Round	MATCH	Upper/ Lower	FIELD	Gap (min)				Next MATCH (MATCH # (ALLIANCE color))		Estimated Start (min)
				Blue	Red	Blue	Red	Winner	Loser	
1	1	Upper	1	A5	A4			M3 (B)	M6 (B)	0
	2	Upper	2	A6	A3			M4 (B)	M5 (B)	6
2	3	Upper	1	W1	A1	0:09		M7 (R)	M5 (R)	12
	4	Upper	2	W2	A2	0:09		M7 (B)	M6 (R)	18
3	5	Lower	1	L2	L3	0:15	0:09	M8 (B)	Tied 5th	24
	6	Lower	2	L1	L4	0:27	0:09	M8 (R)		30
4	7	Upper	1	W4	W3	0:15	0:21	M10 (R)	M9 (R)	36
	8	Lower	2	W5	W6	0:15	0:09	M9 (B)	4th	42
8-minute break										45
5	9	Lower	1	W8	L7	0:08	0:14	M10 (B)	3rd	53
8-minute break										56
Finals	10		1	W9	W7	0:08	0:25	M11*	M11*	64
8-minute break										67
Finals*	11		1	W9	W7	0:08	0:08			75
End of Divisional Playoffs/15 Minute Break Design Award (2, 1), Motivate Award (2, 1)										78
Evt Fin	13		1	DivA	DivB	0:15	0:15	M14	M14	93
15-minute break Control Award (2, 1), Innovate Award (2, 1)										96
Evt Fin	14		1	DivA	DivB	0:08	0:08	M15*	M15*	111
15-minute break Connect Award (2, 1), Think Award (2, 1)										114
Evt Fin	15*		1	DivA	DivB	0:08	0:08			129
Awards: Remaining awards, Finalists, Winners, and Inspire Award										132

* if required

**Awards may be given out after the conclusion of the playoff bracket at the discretion of the Event Director



14 League Play Tournaments (L)

Not all regions offer participation in League play. Leagues are closed groups of teams which play in multiple different League Meet events typically spread over several weeks or months. All the teams in the same League should have the opportunity to play in a roughly equal number of MATCHES. A minimum of 10 League Meet MATCHES should be played by all teams in the League.

League Meet events each play between five (5) and six (6) qualifications MATCHES per team as described in section [13.5 Qualification MATCHES](#) but do not include playoff MATCHES or judging for awards.

In addition, the behavior described in section [10.6.1 YELLOW and RED CARDS](#), verbal warnings and CARDS also clear at the end of each League Meet event.

Teams may belong to only one League per season and can participate in only one League Tournament per season. A team can participate in a League outside their region, provided that is the only league they participate in. A team may not advance from a League Tournament to a Regional Championship that is outside of their region unless the Program Delivery Partners in both regions have agreed to move a team to a new region for the entire season.

League Tournaments function the same as a Qualifying Tournament including for judging and advancement except that qualification rankings as described in section [13.5 Qualification MATCHES](#) are calculated with the addition of each team's top 10 MATCHES played at any League Meet and the matches played at the League Tournament. (Top MATCHES are defined by the sort order in Table 13-1.) Averages for rankings are calculated based on ten (10) MATCHES, regardless of the number of MATCHES played by a team at League Meets. Teams that played fewer than ten (10) MATCHES at League Meets will have RANKING POINTS and MATCH Points that are effectively zero (0) for the missing MATCHES.



15 FIRST Championship (C)

At the 2024-25 FIRST Championship, teams are manually split into four (4) divisions.

Each division plays a standard tournament as described in section [13.5 Qualification MATCHES](#) and section [13.6 Playoff MATCHES](#) to produce the Division Winning ALLIANCES. Those four Division Winning ALLIANCES proceed to the Championship playoffs, on the FIRST Championship FIELDS, to determine the 2024-25 FIRST Tech Challenge Championship Winners, per [15.5 FIRST Championship playoffs](#).

Awards from section [6 Awards \(A\)](#) are all awarded in each division only, except for as shown in Table 15-1.

Table 15-1: FIRST Championship Awards

Award	Per Division	FIRST Championship
Inspire Award	1 st , 2 nd and 3 rd Place	1 st Place
Dean's List	0	10
Compass Award	0	1

15.1 Advancement to the FIRST Championship

Advancement to the FIRST Championship is set by FIRST Headquarters based on the number of teams registered in each region as of December 1st. Advancement for regions outside of North America will be based on previous season registration numbers, if higher.

15.2 Game Modification

The number, type, and distribution of SCORING ELEMENTS may be adjusted for the FIRST Championship INTO THE DEEP tournament. Any game modifications will be published in or before the last regularly scheduled Team Update as described in section [1.9 Team Updates](#).

15.3 3-ROBOT ALLIANCES

ALLIANCES at the FIRST Championship will be made up of 3 ROBOTS. Before each division playoff tournament, ALLIANCES are selected per the process as described in section [13.6.1 ALLIANCE Selection Process](#), however the process continues with a second round of selection as follows:

Round 2: The same method is used for each ALLIANCE lead's second choice except the selection order is reversed, with ALLIANCE 8 picking first and ALLIANCE 1 picking last. This process results in 8 ALLIANCES of 3 teams each.

ALLIANCES may start each of their MATCHES with any 2 of the 3 ROBOTS on their ALLIANCE during Division and Championship playoff MATCHES. ALLIANCES do not need to inform FIELD STAFF of which two ROBOTS will play ahead of the MATCH but must not delay the start of the MATCH per [G301](#) by making a late decision.

C301 *Replays use the same ROBOTS. If a playoff MATCH must be replayed, the two ROBOTS used in the replay must be the same as in the original MATCH. The sole exception is: if, in the opinion of the Head REFEREE, the ARENA FAULT rendered a ROBOT inoperable, in which case the ROBOTS can be changed.

If an additional MATCH is played due to a tie, any 2 of the 3 ROBOTS may be played in the additional MATCH.

15.4 FIRST Championship Pit Crews

Each team on an ALLIANCE playing in the FIRST Championship playoffs may have an additional 2 pit crew team members inside the ARENA to assist with pre-MATCH strategy, ROBOT repair and maintenance, and other team support functions. Additional pit crew members must stay in the pit areas of the ARENA.

The additional team members may be adults or STUDENTS.

15.5 FIRST Championship playoffs

The 4 Division Winning ALLIANCES play a double elimination style tournament as described in section [13.6 Playoff MATCHES](#) to determine the 2024-25 INTO THE DEEP FIRST Tech Challenge Championship Winners. Exact MATCH timing is provided to FIRST Championship playoff teams. Divisions are ranked by the criteria in Table 13-1 excluding Rank Score. ALLIANCES are paired as shown in Figure 15-1.

Figure 15-1: FIRST Championship playoff bracket

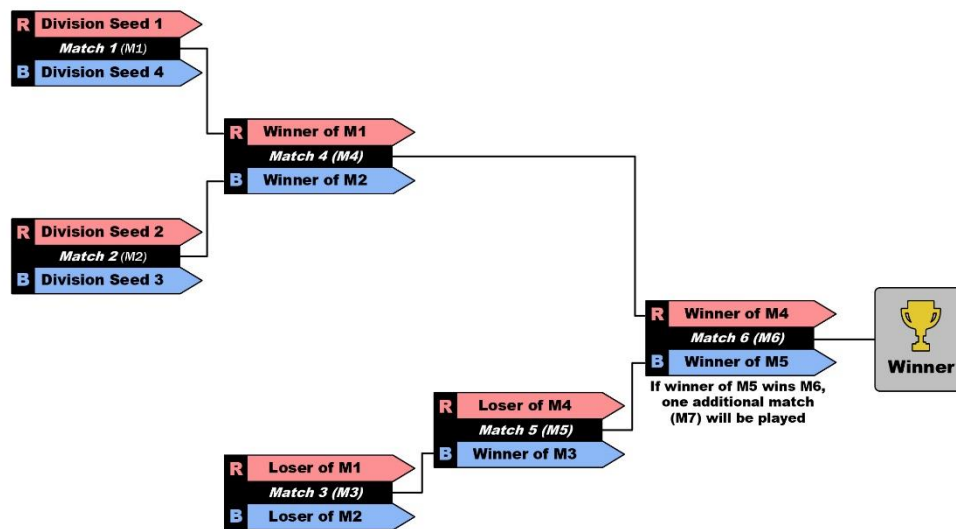

During the FIRST Championship playoffs, if an additional MATCH is played due to a tie, any two of the three ROBOTS may be played in the additional MATCH.



16 Glossary

The following definitions and terms are used for a *FIRST* Tech Challenge game INTO THE DEEP. Defined terms are in ALL CAPITAL LETTERS throughout the manual (for example, ALLIANCE). Competition rules mean what they plainly say. If a word is not given a game definition, then you should use its common conversational meaning.

Term	Definition
ALLIANCE	a cooperative of two <i>FIRST</i> Tech Challenge teams
ALLIANCE AREA	a 120 in. (~304.8 cm) wide by 42 in. (~106.7 cm) deep by infinitely tall volume formed by placing ALLIANCE colored tape onto the flooring surface outside of the FIELD.
ALLIANCE CAPTAIN	The designated STUDENT representative from each ALLIANCE lead is called the ALLIANCE CAPTAIN.
ALLIANCE SPECIFIC	elements owned or associated with a specific ALLIANCE
ARENA	includes all elements of the game infrastructure that are required to play this season's FTC game including: the FIELD, SCORING ELEMENTS, queue area, team media area, and all equipment needed for FIELD control, ROBOT control, and scorekeeping
ARENA FAULT	an error in ARENA operation
ASCEND/ASCENDED/ASCENT	A ROBOT is considered ASCENDING once it is attempting to achieve an ASCENT LEVEL, and ASCENDED once it has achieved an ASCENT LEVEL.
ASCENT ZONE	an infinitely tall 5-sided polygon that is formed from two 9.25 in. (~23.5 cm) long sides bounded by the SUBMERSIBLE outriggers, one 44.75 in. (~113.7 cm) long side bounded by the barrier of the SUBMERSIBLE, and the two 26 in. (~66 cm) long sides bounded by white tape that extend from the outriggers to a point 20 in. (~50.8 cm) from the barrier. The ASCENT ZONE includes the taped lines.
AUTO	the first 30 seconds of the MATCH, during which DRIVERS may not provide input to their ROBOTS, so ROBOTS operate with only their pre-programmed instructions
BASKET (LOW and HIGH)	molded plastic containers which have an 8.85 in. (~22.5 cm) wide by 5.5 in. (~14.0 cm) top opening
CHAMBERS	There are two CHAMBERS per ALLIANCE in the SUBMERSIBLE. The LOW CHAMBER is made of HIPS plastic pipe and is 13 in. (~33.0 cm) from the FIELD floor to the top of the 1.05 in. (~2.7 cm) pipe.

Term	Definition
CHASSIS	A ROBOT'S MAJOR MECHANISM that enables it to move around a FIELD
CLIP	a black plastic SCORING ELEMENT which is designed to be connected to an ALLIANCE SPECIFIC SAMPLE by a HUMAN PLAYER or ROBOT to create a SPECIMEN
COMPONENT	any part in its most basic configuration, which cannot be disassembled without damaging or destroying the part or altering its fundamental function
CONTINUOUS	describes durations that are more than approximately 10 seconds
CONTROL	an action by a ROBOT in which the SCORING ELEMENT is fully supported by or stuck in, on, or under the ROBOT or it intentionally pushes a SCORING ELEMENT to a desired location or in a preferred direction (i.e., herding). Typically, CONTROL requires one of the following to be true: <ul style="list-style-type: none"> A. The SCORING ELEMENT is fully supported by the ROBOT B. The ROBOT is moving the SCORING ELEMENT in a preferred direction with a flat or concave face of the ROBOT
COTS	a standard (i.e., not custom order) part commonly available from a VENDOR for all teams for purchase
CUSTOM CIRCUIT	Any active electrical item that is not an actuator (specified in R501 or R502) or core control system item (specified in R712)
DISABLED	The REFEREE instructs the team to stop the ROBOT which will deactivate all outputs, rendering the ROBOT inoperable for the remainder of the MATCH
DISQUALIFIED	the state of a team in which they receive 0 MATCH points and 0 RANKING POINTS in a qualification MATCH or causes their ALLIANCE to receive 0 MATCH points in a playoff MATCH
DRIVE COACH	a guide or advisor
DRIVE TEAM	a set of up to 4 people from the same FIRST Tech Challenge team responsible for team performance for a specific MATCH
DRIVER	an operator and controller of the ROBOT
DRIVER STATION	Android device (smartphone or REV Driver Hub) that runs the DRIVER STATION App software to communicate with a ROBOT per R901
FABRICATED ITEM	any COMPONENT or MECHANISM that has been altered, built, cast, constructed, concocted, created, cut, heat treated, machined, manufactured, modified, painted, produced, surface coated, or

Term	Definition
	conjured partially or completely into the final form in which it will be used on the ROBOT
FIELD	an approximately 12 ft. (3.66m) by 12 ft. (3.66m) tile area bounded by the outside edge of the extrusion that frames the walls
FIELD STAFF	volunteers present in and around the ARENA that are responsible for making sure the MATCHES are cycled through efficiently, fairly, safely, and with a spirit of cooperation, <i>Gracious Professionalism</i> [®] , and generosity of spirit
FTA	<i>FIRST</i> technical advisor, an event volunteer role
HUMAN PLAYER	a SCORING ELEMENT manager
INSPECTOR	a person determined by <i>FIRST</i> to accurately and efficiently assess the legality of a given part or the whole of a ROBOT, an event volunteer role
JUDGE	Judges meet with teams to learn about and celebrate the unique journey and accomplishments of each team and evaluate these against award requirements. Judges interact with students during the interview process and in the pits. As a group, Judges determine the teams that receive awards at events
LAUNCH/LAUNCHING	shooting into the air, rolling/kicking across the floor with an active mechanism, or throwing in a forceful way
LEVEL	LEVELS are ROBOT scoring achievements as defined in Table 10-2
LRI	the lead ROBOT INSPECTOR, an event volunteer role
MAJOR FOUL	a credit of 15 points towards the opponent's MATCH point total
MAJOR MECHANISM	a group of COMPONENTS and/or MECHANISMS assembled together to address at least 1 game challenge: ROBOT movement, SCORING ELEMENT manipulation, FIELD element manipulation, or performance of a scorable task without the assistance of another ROBOT.
MATCH	a 30 second AUTO period, an 8 second transition period between AUTO and TELEOP, and a 2-minute TELEOP period in which the ROBOT plays the current season game
MECHANISM	an assembly of COMPONENTS that provide specific functionality on the ROBOT. A MECHANISM can be disassembled (and then reassembled) into individual COMPONENTS without damage to the parts.
MINOR FOUL	a credit of 5 points towards the opponent's MATCH point total

Term	Definition
MOMENTARY	describes durations that are fewer than approximately 3 seconds
NET ZONE	an infinitely tall triangle bounded by the FIELD walls located beneath the BASKETS and ALLIANCE colored tape that is diagonal from corner to corner across the TILE. The outside edge of the tape is 22.75 in. (~57.8 cm) away from the FIELD corner when measured at the FIELD wall. The NET ZONE includes the taped lines.
OBSERVATION ZONE	an infinitely tall 4-sided polygon which is 36.6 in. (~92.9 cm) at the widest point by 13.1 in. (~33.3 cm) long bounded by ALLIANCE colored tape and the adjoining FIELD wall. The OBSERVATION ZONE includes the taped lines.
OPERATOR CONSOLE	the set of COMPONENTS and MECHANISMS used by the DRIVE TEAM to relay commands to the ROBOT
PARK	when the ROBOT is fully or partially inside the OBSERVATION ZONE at the end of a MATCH period
PIN/PINNING	Preventing an opposing ALLIANCE ROBOT from moving, accessing, or exiting an AREA for an extended period by obstructing ALL paths of travel this includes the following conditions: <ul style="list-style-type: none"> A. Limiting the movement of an opponent ROBOT to a small or confined area of the FIELD, approximately one foam TILE or less, without an avenue for escape. If a ROBOT is not attempting to escape it's not considered a violation. B. Preventing the movement of an opponent ROBOT directly or transitively through contact with the FIELD perimeter, game structure, another ROBOT. C. Controlling an opponent's movements by raising or tilting the opponent's ROBOT off the TILES.
PLOWING	inadvertent contact with a SAMPLE or SPECIMEN, typically via a flat or convex surface, while in the path of the ROBOT moving about the FIELD
RANKING POINTS (RP)	ALLIANCES are rewarded RANKING POINTS (RP) for winning or tying MATCHES, which is determined by MATCH points earned by each ALLIANCE.
RANKING SCORE (RS)	A team's RANKING SCORE (RS) is the average number of RANKING POINTS earned by a team throughout their qualification MATCHES
RED CARD	a penalty assessed for egregious ROBOT or team member behavior or rule violations which results in a team being DISQUALIFIED for the MATCH.

Term	Definition
REFEREE	an official who is certified by <i>FIRST</i> to enforce the rules of the current season's game, an event volunteer role
REPEATED	describes actions that happen more than once within a MATCH
ROBOT	an electromechanical assembly built by the <i>FIRST</i> Tech Challenge team to play the current season's game and includes all the basic systems required to be an active participant in the game –power, communications, control, and movement about the FIELD
ROBOT CONTROLLER	Android device (smartphone or REV Control Hub) that runs the ROBOT CONTROLLER app to control the ROBOT as defined in R701
ROBOT SIGN	A ROBOT SIGN simultaneously identifies a ROBOT'S team number as well as its ALLIANCE affiliation for FIELD STAFF.
RUNG (LOW and HIGH)	The RUNGS are 1in. (~2.5 cm) diameter aluminum extrusion which are 44.5 in. (~113 cm) long and are attached to vertical metal extrusions that make up the SUBMERSIBLE frame
SAMPLE	A SAMPLE is a 3.5 in. (8.9 cm) long by 1.5 in. (3.8 cm) wide by 1.5 in. (3.8 cm) high rectangular prism shaped SCORING ELEMENT.
SCORING ELEMENT	There are two different physical elements used in INTO THE DEEP: the SAMPLE and the CLIP. Red or blue ALLIANCE SPECIFIC SAMPLES can be combined with a CLIP to create a SPECIMEN.
SIGNAL LEVEL	a term used to characterize circuits which draw $\leq 1A$ continuous and have a source incapable of delivering $>1A$, including but not limited to REV Control and Expansion Hub sensor input/output signals (DIO, analog, I2C, encoder, 485)
SPECIMEN	A SPECIMEN is a SCORING ELEMENT that is made up of one ALLIANCE SPECIFIC SAMPLE and at least one CLIP.
SPIKE MARK	one of twelve 3.5 in. (~8.9 cm) long marks used to identify the placement of SAMPLES before the MATCH. The 3 marks in front of the OBSERVATION ZONES are of ALLIANCE colored tape and the 3 marks in front of each NET ZONE are made of white tape
STARTING CONFIGURATION	the physical configuration in which a ROBOT starts a MATCH
STUDENT	a person who has not completed high-school, secondary school, or the comparable level as of September 1 prior to Kickoff
SUBMERSIBLE	A SUBMERSIBLE is a structure where ROBOTS collect SAMPLES, score SPECIMENS onto the CHAMBERS, and ASCEND using RUNGS.

Term	Definition
SUBMERSIBLE ZONE	SUBMERSIBLE ZONE: a 27.5 in. (~69.9 cm) wide by 42.75 in. (~108.6 cm) long, infinitely tall volume bounded by the inner most edge of the barriers of the SUBMERSIBLE
SURROGATE	a team randomly assigned by <i>FIRST</i> event management software to play an extra qualification MATCH
TELEOP	second period of each MATCH is 2 minutes (2:00) and called the teleoperated period (TELEOP). During TELEOP, DRIVERS remotely operate ROBOTS
TILE	flooring surface of the FIELD is made of 36 (nominal) 24 in. x 24 in. x 5/8 in. interlocking soft foam TILES
VENDOR	a legitimate business source for COTS items that satisfies criteria defined in section 12 ROBOT Construction Rules (R)
YELLOW CARD	a warning issued by the REFEREE for egregious ROBOT or team member behavior or rule violations
WTA	Wi-Fi technical advisor, a volunteer role

